

# THUNDER LASER SYSTEMS

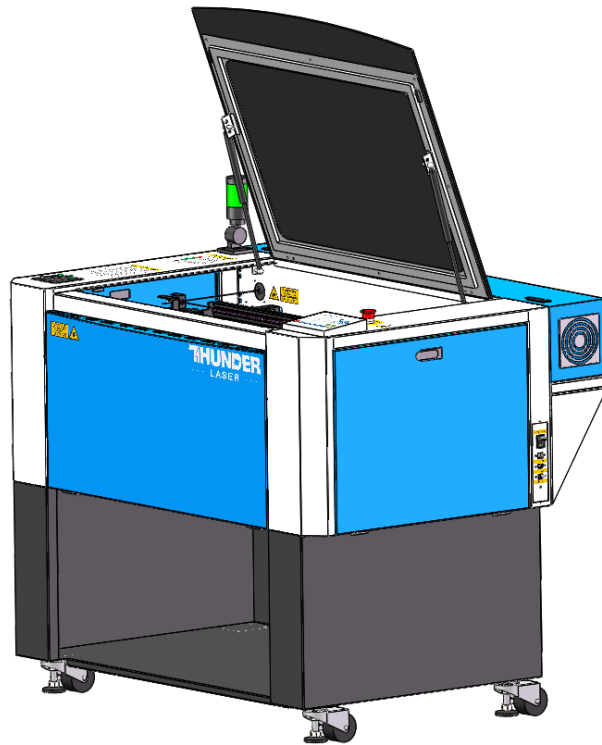

## ODIN Series Unified User's Manual

For ODIN 22, 32

Thunder Laser

[www.thunderlaser.ca](http://www.thunderlaser.ca)

[sales@thunderlaser.ca](mailto:sales@thunderlaser.ca)

**February 2022**

Fuse33 Makerspace

1720 Radisson Drive SE Calgary, AB, Canada. T2A1Z8

# Introduction

This manual has been designated as the thunder laser systems, laser cutting machine installation and user guide;The manual is divided into five chapters, including general information instructions, safety instructions, the key components of every laser cutting systems and the installation steps, operation instructions and maintenance instructions from THUNDERLASER Company.

First, it should be emphasized that the installation of each system must meet the requirements, and make it consistent with the installation requirements of THUNDERLASER. If not, the machine will not working properly, poor performance, life shortened, maintenance costs increased and even machine damage.

The note is for getting a specific requirement of system installation, and we hope every customer try to understand these notes before installation and usage, thus you can correctly install and use. If you meet any installation problems, you can contact our technical staff and customer service staff.

**At the same time, you can also refer to the machine installation video that we posted on YouTube. The specific URL is:**

<http://www.thunderlaser.com/how-to-use-your-laser-machine/how-to-setup-your-nova-laser-cutter.html>

Or

<https://www.youtube.com/watch?v=NpLo1L0NQx8&list=PLjSZrgjcrhs7QucNN-3jx7rZapDGfjG-5>

**Contents**

**CHAPTER 1. GENERAL..... 5**

1.1 GENERAL INFORMATION ..... 5

1.2 DESIGNATED..... 6

1.3 DISPOSAL REMARKS ..... 6

1.4 TECHNICAL DATA / DEVICE SPECIFICATION..... 7

1.5 EC DECLARATION OF CONFORMITY ..... 9

1.6 ROSH CERTIFICATE..... 10

1.7 MANUFACTURER'S LABEL..... 11

**CHAPTER 2. SAFETY.....12**

2.1 GENERAL SAFETY INFORMATION..... 12

2.2 LASER SAFETY INFORMATION ..... 13

2.3 SAFETY PRECAUTIONS WHEN OPERATING THE DEVICE ..... 14

2.4 WARNING AND INFORMATION LABELS ..... 15

**CHAPTER 3. PROCESS OF INSTALLING .....18**

3.1 UNPACKING ..... 18

3.2 LOCATION ..... 18

3.3 BEFORE INSTALLATION ..... 20

3.4 EXHAUST SYSTEM – REQUIREMENTS ..... 22

3.5 AIR SYSTEM – REQUIREMENTS..... 22

3.6 COMPUTER – REQUIREMENTS ..... 23

3.7 CONNECTIONS ..... 24

3.7.1 *Connecting the Mains* ..... 24

3.7.2 *Connecting the Computer* ..... 25

3.7.3 *Connecting the Air System* ..... 26

3.7.4 *Connecting the Exhaust System* ..... 28

**CHAPTER 4. OPERATION.....30**

4.1 MACHINE VIEW ..... 30

4.2 ON/OFF SWITCH ..... 34

4.3 HOW TO SETUP THE OEM SOFTWARE ..... 35

4.3.1 *Software installation* ..... 35

4.3.2 *Make connection between PC and machine* ..... 37

4.4 HOW TO USE THE DISPLAY ..... 40

4.4.1 *Function of the Buttons*..... 40

4.4.2 *The main interface* ..... 42

4.4.3 *Speed button*..... 43

4.4.4 *Max Power buttons*..... 43

4.4.5 *Set the Layer Parameters*..... 43

4.4.6 *Menu button* ..... 44

4.4.7 *File button* ..... 45

4.5 HOW TO ADJUST FOCUS DISTANCE BY MANUAL OR AUTO ..... 47

4.6 HOW TO USE THE DIFFERENT OPTIONAL LENS(1.5" , 2.5" & 4") ..... 49

4.7 HOW TO USE THE TL-TIMER ..... 51

4.8 HOW TO USE AIR-ASSIST CONTROL (IF EQUIPPED)..... 53

4.9 HOW THE HEAT ALARM SYSTEM WORKS ..... 55

4.10 THE FIRST TIME RUNNING THE LASER..... 57

4.11 WORKSTATION AREA INDICATION ..... 61

4.12 HOW TO USE THE CHUCK ROTARY AXIS ATTACHMENT ..... 62

4.13 FOR LASER ENGRAVING ..... 64

**CHAPTER 5. MAINTENANCE .....65**

5.1 CLEANING THE LASER MACHINE ..... 65

5.2 CLEANING THE OPTICAL PARTS..... 66

    5.2.1 *Cleaning the Focus Lens* ..... 67

    5.2.2 *Cleaning the Mirrors* ..... 68

    5.2.3 *Cleaning Laser Combiner* ..... 70

5.3 CHECK THE BEAM PATH ..... 71

5.4 MAINTAIN THE X/Y/Z RAILS..... 72

5.5 MAINTENANCE PLAN ..... 73



## Chapter 1. General

### 1.1 General Information

Please read this documentation carefully before installation and operation.

**Injury, death, loss of property, fire, electric shock, malfunction, reduced performance & machine life, and critical failures can result from not reading, understanding, and following the Operation Manual!**

Operation of the system is permitted only with equipment and spare parts supplied or listed in the spare parts and consumables lists. The use of 3<sup>rd</sup> Party components may void the warranty.

Auxiliary equipment must be adjusted to the base machine (contact us for further info).

The following symbols are used throughout the Operation Manual:



**Caution:** Warnings to keep in mind when operating the laser.



**High Voltage:** Care must be taken to prevent injury and/or death.



**Laser Radiation:** Pay attention to the dangers of the laser beam.



**Fire Hazard:** High potential for fire. NEVER RUN UNATTENDED!



**Tips:** Helpful notes or info that simplify the use or understanding.

## 1.2 Designated

The THUNDER LASER ODIN SERIES is used for engraving and cutting of signs, stamps and suchlike.

A wide variety of materials such as rubber, acrylic, coated metal, tin, special steel, anodized aluminum, cork, cardboard, glass, leather, marble, several plastics and wood can be processed on the laser.



1. The engraving process must only be performed with a perfectly adjusted machine.
2. Use of the system in other areas is against the designated use. The manufacturer does not admit liability for damage to personal and/or equipment resulting from such use.
3. The system must only be operated, maintained and repaired, by personnel that are familiar with the designated field of use and the dangers of the machine!
4. Non-observance of the instructions for operation, maintenance and repair described in this Operation Manual excludes any liability of the manufacturer if a defect occurs.
5. Caution when processing conductive materials (carbon fibers), Conductive dust or particles in the ambient air might damage electrical components and lead to short circuits. Bear in mind that those defects are not warranted.

## 1.3 Disposal remarks



### **Do not dispose the machine with domestic waste!**

Electronic devices have to be disposed according to the regional directives on electronic and electric waste disposal. In case of further questions, please ask your supplier. He might take care of proper disposal.

## 1.4 Technical Data / Device Specification

### Mechanics

System	ODIN22	ODIN32
Working Area	22"X 15"/559 x 381 mm	32"X 20"/813 X 508mm
Table Size	24.6"X17.3"/625 x 440mm	35"X 22.3"/899 X 567 mm
Z Axis Height	7.3"/185 mm	7.3"/185mm
Max Work Height	8.2"/210 mm	8.2"/210 mm
Max Speed	2000mm/sec	
Max work size	Below 1000mm/s	Below 1000mm/s
	20.8"x 15"/ 529 x381mm	30.8" x 20"/ 783 x508mm
	Below 2000mm/s	Below 2000mm/s
	18"x 15"/461 x381mm	28" x 20"/ 715 x508mm
Motor	High-speed Stepper	
Working piece table	Honey comb table	
Max table load	20kgs	20kgs
Net Weight	145kgs	167kgs
Standard Head	2.0" (50.8mm)	
Lens Diameter	20mm	
Mirror Diameter	20mm	
Beam Comb. Dia	20mm	

### Dimensions

	ODIN22	ODIN32
W x D x H	40.6"X34"X41.7"/1030x860x1090mm	51"x 39"x 43"/1284x987x1090mm

### Max Part Size (W x L x H)

	ODIN22	ODIN32
<b>Door Closed</b>	24.6"X17.3"X 7.5"/625 X440X190mm	35"X 22.3"X 7.4"/879 x 567 x 190mm

### Features

#### Standard:

100% faster motor system, 100% smoother guide Rail, 1000DPI RF metal laser source, Upper lower vent, Eight fold Open flap protection, Heat alarm detector, Dual air-assist control, Newly-designed focus lens and mirror holder, New housing design, Drawer for collecting small working pieces, Visible Red Dot Pointer, New Auto Focus, Smart board, Honey Comb Table, High quality power cable, Alarm lamp, Emergency Stop , 3D Engraving/Cutting, Breaker, Earth wiring, Rotary plug, Maintenance mode, Exhaust system.

**Optional:**

Rotary Attachment, High air compressor set (Includes water filter), 1.5", 2.5" & 4" Focus lenses

**Control System**

Laser power	Adjustable from 1 - 100% (typically 5-100%)
Interface Hardware	USB: connect to PC and U-disk Ethernet: connect to PC
Interface Software	LightBurn - RDWorksV8
Operating Modes	Optimized raster, vector, and combined mode
Buffer Memory	128 MB standard

**Laser Equipment**

Laser Type:	Sealed Radio frequency Laser Tube
Standard Laser Power:	30w
Wavelength:	10.6µm
Red dot pointer:	Laser Power < 1mW
Wavelength:	630nm – 680nm

**Cooling System**

Machine Cooling System:	Air-Cooled
Tube Cooling System:	Air-Cooled

**Electricity, Power, Breaker**

	30W	60W
Electricity Requirement	110V or 220 Volt AC, 50 or 60Hz, Single phase <b>Machine requires either 110V or 220V voltage(customized from factory); Support both 50Hz and 60Hz, single phase</b>	
Power consumption	1, 110V 689.5W, 220V	1156W, 220V 1145W, 110V
Recommended circuit breaker	20A, 110V 10A, 220V	20A, 110V 10A, 220V

**Ambient Conditions**

Ambient temperature	+15°C to +35°C / 59°F to 95°F
Humidity	40% to max. 70%, not condensing

**Laser Safety**

Laser Class	Laser Class 2
Laser Safety	CE compliant FDA approved

## 1.5 EC Declaration of Conformity

### EC Declaration of Conformity

**We**

Dongguan Thunder Laser Equipment Co., Ltd.

**Company's address**

Mintian, Shatian Dadao, Shatian Town, Dongguan, Guangdong, China

**declares that the product described is in conformity with**

**The Machinery Directive: 2006/42/EC and The EMC Directive: 2004/108/EC**

**Applicable Harmonized standards:**

EN ISO 11553-1:2008

EN 60204-1:2006+A1:2009

EN ISO 12100:2010

EN 60825-1:2014

EN ISO 13849-1:2008/AC:2009

EN ISO 13849-2:2012

**Product Name**

Laser System

**Product Model**

NOVA 24, NOVA 35, NOVA 51, NOVA 63, MINI 60, ODIN 22, ODIN 32

**Trade Mark**



**Name and address of the person authorized to compile the technical file**

Name: Tom Tang, Address: Banalog Farm, Banalog Terrace Hollybush Caerphilly, UK, NP12 0SF

**Authorized Representative:**

We guarantee that we will provide the authorized representative information before we export the machine to E.U.

**Responsible for making this declaration is the**

**Manufacturer**

**Authorized representative established within the EU**

2020-07-04

Mintian, Shatian Dadao,  
Shatian Town,  
Dongguan, Guangdong,  
China

**Issue date and Place**

Tom Tang

General Manager

**Name and position**



**Signature and company stamp**

## 1.6 Rosh Certificate

  
**C E R T I F I C A T E**  
**ATTESTATION**  
**CERTIFICATE OF RoHS COMPLIANCE**  
**DIRECTIVE 2011/65/EU**

Technical File of the company mentioned below has been inspected and assessment has been completed successfully  
2011/65/EU RoHS Compliance of Directive have been taken as references for these processes

Company Name : Dongguan Thunderlaser Industrial Co., Ltd.

Company Address : 109, Building 2, 159 Shatian Avenue, Shatian Town, Dongguan city, Guangdong Province, China, 523980

Related Directives and Annex : Directive 2011/65/EU Restriction of the Use of Certain Hazardous Substances in Electrical and Electronic Equipment

Related Standards : EN 50581:2012

Product Name : Laser cutter

Report No and Date : ZTL-2022011701R

Product Brand/Model/Type : Thunderlaser// Nova35 Nova24, Nova35, Nova51, Nova63, Mini60

Certificate Number : M.2021.206.C70945

Initial Assessment Date : 21.01.2022

Registration Date : 24.01.2022

Reissue Date/No : -

Expiry Date : 23.01.2027

  
UDEM International Certification  
Auditing Training Centre Industry  
and Trade Inc.Co

The validity of the certificate can be checked through [www.udemita.com.tr](http://www.udemita.com.tr). The CE Mark shown on the right can only be used under the responsibility of the manufacturer with the completion of EC Declaration of Conformity for all relevant directives. Other relevant directives for CE Marking directives have not been considered during RoHS assessment even they may apply. The result relates only to the item(s) tested and no amounts above the limites have been detected. This certificate remains as the property of UDEM International Certification Auditing Training Centre Industry and Trade Co., Ltd. whom it must be returned upon request. The above names firm must keep a copy of this certificate for 15 years from the registration of certificate. This certificate only covers the product(s) stated above and UDEM must be notified in case of any change(s) on the product.

**Address:** Mutlukent Mahallesi 2073 Sokak (Eski 93 Sokak) No:10 Çankaya – Ankara – TURKEY  
**Phone:** +90 0312 443 03 90 **Fax:** +90 0312 443 03 76  
**E-mail:** [info@udemita.com.tr](mailto:info@udemita.com.tr) [www.udemita.com.tr](http://www.udemita.com.tr)





## 1.7 Manufacturer's Label

The manufacturer's label is located on the back of the device (see Figure below).

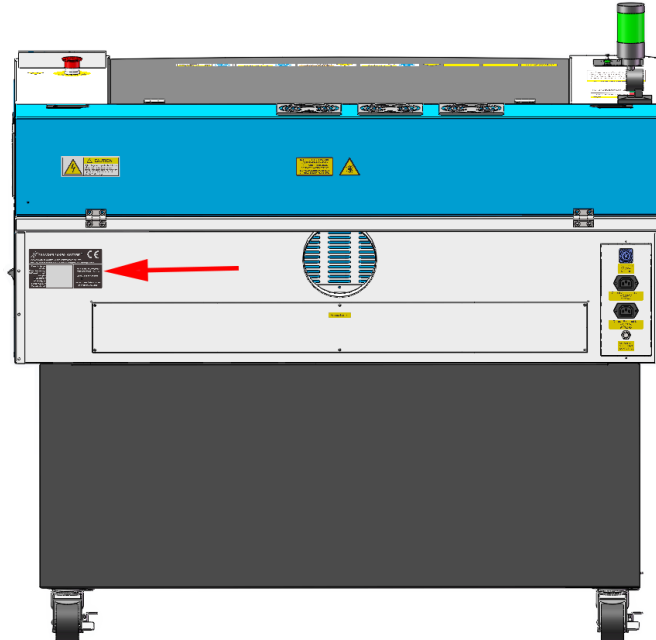

It is recommended to record all of the data so that you always have this handy. You will need to supply your Serial Number to our Support Team on occasion.

 <b>THUNDER LASER CUTTER</b> 	
<b>DONGGUAN THUNDER LASER EQUIPMENT CO.,LTD</b> Shatian Town, Shatian Dadao, Mintian, Dongguan City, Guangdong Province, China	
<b>Rated voltage:</b> <b>Phase:</b> <b>Rated frequency:</b> <b>Full load current:</b> <b>Weight:</b> <b>Lasertype:</b> <b>Model/Type:</b> <b>Serial Number:</b> <b>Manufactured:</b>	Complies with 21 CFR 1040.10 and 1040.11 except for deviations pursuant to Laser Notice No. 50, dated June 24, 2007  This Product Complies With EN 60825-1:2014.  <b>Class 2 Laser Product</b> <b>www.thunderlaser.com</b> <b>MADE IN CHINA</b>



## Chapter 2. Safety

### 2.1 General Safety Information

All personnel involved in installation, set-up, operation maintenance and repair of the machine, must have read and understood the Operation Manual and in particular the "Safety" section. The user is recommended to generate company-internal instructions considering the professional qualifications of the personnel employed in each case, and the receipt of the instruction/Operation Manual or the participation at introduction/training should be acknowledged in writing in each case.

#### Safety-conscious of Working

The machine must only be operated by trained and authorized personnel.

The scopes of competence for the different activities in the scope of operating the machine must be clearly defined and observed, so that under the aspect of safety no unclear questions of competence occur. This applies in particular to activities on the electric equipment, which must only be performed by special experts.

For all activities concerning installation, set-up, start-up, operation, modifications of conditions and methods of operation, maintenance, inspection and repair, the switch-off procedures that may be provided in the Operation Manual must be observed.

#### Safety Information for the User and/or Operating Personnel



1. No working methods are permitted that affect the safety of the machine.
2. The operator must also ensure that no unauthorized persons work with the machine (e.g. by activating equipment without authorization).
3. It is the duty of the operator, to check the machine before start of work for externally visible damage and defects, and to immediately report changes that appear (including behavior during operation) that affect the safety.
4. The user must provide that the machine is only operated in perfect condition.
5. The user must guarantee the cleanness and accessibility at and around the machine by corresponding instructions and controls.
6. No safety components may be removed or disabled (again we emphasize the imminent dangers, for example severe burns, loss of eyesight, etc...). If the removal of safety components is required during repair and service, the replacement of the safety components must be performed immediately after completion of the service and repair activities.
7. Preparation, retooling, change of work piece, maintenance and repair activities **must only performed with equipment switched off** and by trained personnel.



8. **Any attempt to perform unauthorized modifications and changes to the machine can VOID THE WARRANTY.** This does not apply to preventative & general maintenance, adjustment and alignment, etc... that follow Thunder Laser's best practices.

## 2.2 Laser Safety Information



1. To assess the potential dangers laser systems pose, they are classified into 2 safety classes, Thunder Laser ODIN series is a device of class 2. This is guaranteed by the protective housing and the safety installations.

Please note that improper and warranty operation of the device can override the status of Safety class 2 and can cause the emission of harmful radiation.

2. This laser engraving system contains a carbon dioxide (CO<sub>2</sub>) laser of class 4 that emits intensive and invisible laser radiation. Without safety precautions the direct radiation or even diffuse reflected radiation is dangerous!

3. Without safety precautions, the following risks exist with exposure to laser radiation:

Eyes: Burns to the cornea

Skin: Burns

Clothing: Danger of fire

4. Never try to modify or disassemble the laser and do not try to start up a system that had been modified or disassembled!

5. Dangerous radiation exposure can result from the use of operation or adjustment equipment other than that described here, and if different operational methods are performed.

## 2.3 Safety Precautions when Operating the Device

Your Thunder Laser ODIN SERIES has an integrated safety system which immediately stops the job when the protection cover (Lid) is opened. An incomplete job will occur if the cover is opened during operation. Press the "PAUSE" button first if you want to interrupt an engraving process.

**Please remember the following safety precautions when working with this device:**



1. CO2 Fire extinguishers should be placed near laser. Always keep a properly maintained and inspected fire extinguisher on hand.
2. Do not store any flammable materials in the inside of the device. Particularly leftovers of produced materials have to be removed to prevent fire hazard.
3. Please maintain free airflow around this system at all times. Do not cover the machine while in operation.
4. Stay with the laser. Do not leave the laser unattended when it is working, small scraps can ignite and without supervision can destroy the machine if not checked.
5. Use Air Assist. Always use the system's Air Assist feature when vector cutting.



1. These lasers emit invisible radiation; safety glasses should be worn when maintaining these machines for your protection.
2. Adjustment of the beam path must be performed only by specially trained personnel. An improper setting can lead to uncontrolled emission of the laser radiation.



1. Do not disable limit switches or safety features as this can invalidate warranties and cause damage to you and the machine.
2. Before processing materials the user must verify whether harmful materials can be generated and whether the filter equipment of the exhaust system is suitable for the harmful materials. We emphasize that it is the responsibility of the user, to consider the national and regional threshold values for dust, fogs and gases when selecting the filters and the exhaust system. (The values for the maximum workplace concentration must not be exceeded.)
3. PVC (polyvinyl chloride) must under no circumstances be processed with the laser.

## 2.4 Warning and Information Labels



The warning and information labels in various locations if the machine should always be read carefully and understood. If labels are lost or damaged, they must be replaced immediately.

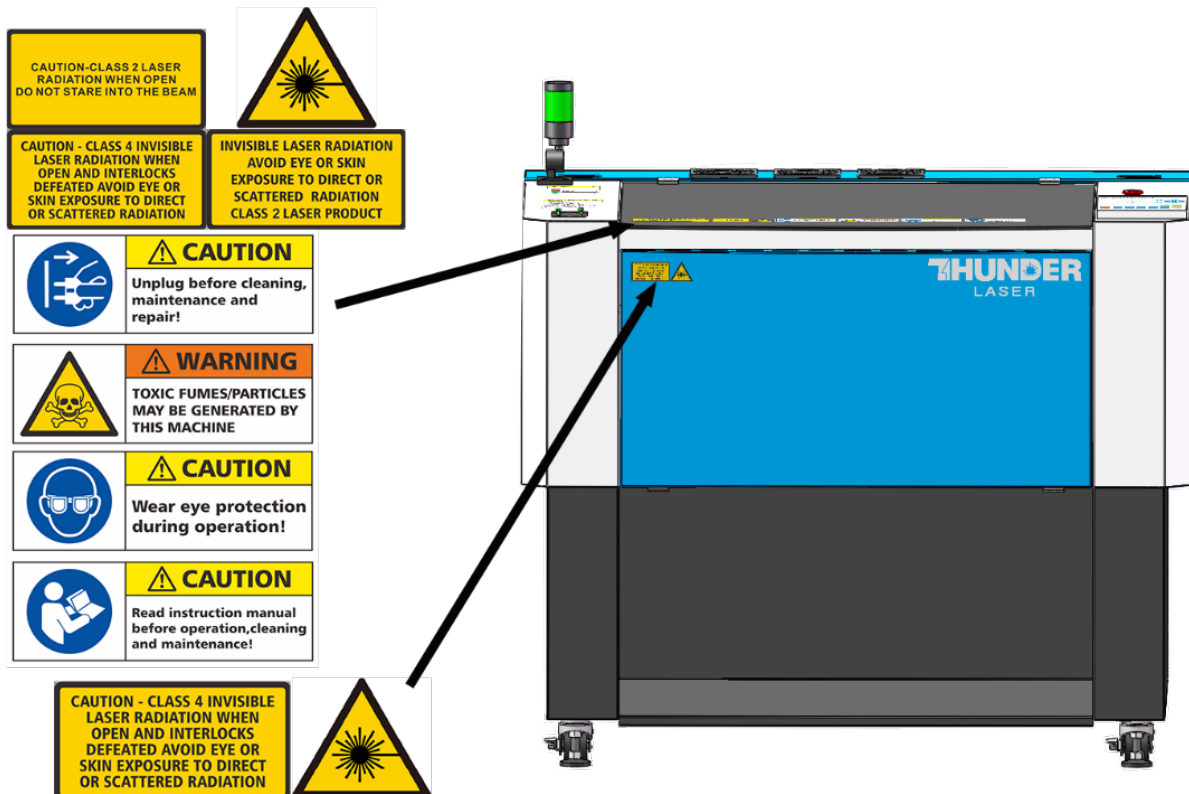

**ATTENTION**

- The management & operator must read the operating manual carefully before operating this machine. Do not operate this machine without training.
- Never under any circumstance run this machine if the water cooling is not circulating, damage will very rapidly occur to the laser tube if you do.
- Never leave laser running unattended and always activate cut off switch when work is finished.
- Pay close attention to the machine while it is running, and be prepared to pause the process and if necessary use the E-stop.
- This machine contains multiple risks of invisible laser radiation(heat) and high voltage, in combination with water cooling, and must be electrically earthed. In the case of a fault, never try to disassemble the machine, contact service provider and turn off power.
- Service, maintenance and repairs must be conducted by trained professionals.
- Do not operate this laser machine with any of the covers open, or attempt to defeat any of the safety interlocks. Doing so can result in burns, and there is potential for permanent damage to your eyesight.
- The environment conditions of your production facility are crucial to the machines potential lifespan. Specifically a void high humidity, airborne dust and fluctuating temperatures. Do not allow the machine to freeze.
- The optimal environmental temperature for the water cooling system ranges between 15 and 30°C. Only use distilled water and replace it regularly up to four times a year to maintain purity. Any additive put in the water will damage the laser tube seals and the pump inside the water chiller unit.
- Do not store any flammable materials on or near the laser. The laser uses invisible radiation(heat) to vaporize combustible materials - fire is a severe risk with Co2 lasers.
- Regular cleaning of reflective mirrors and the focusing lens is essential to prevent power loss.
- Remove offcuts and waste material from the interior of the machine, and regularly check and clear the extraction system to prevent buildup of soot and dust which can fuel a fire.
- Do not attempt to laser mark or cut reflective materials, this can result in reflected invisible laser radiation(heat), which will damage the machine.
- Keep a serviced Co2 fire extinguisher nearby the laser always.
- Dry powder extinguishers will cause irreparable corrosion if used.
- In the case of any uncontrolled event or failure of your system, always contact your service provider to receive professional assistance, so work can resume in a timely & safe manner.

Thank you for your cooperation!

**ATTENTION**

**Function of the signal lamp**



**If laser machine is running a job or user starts it without closing door or water protection, the signal lamp is in red light.**

**The red light indicates the dangerous situation and user must stay with the laser.**

**If laser machine is not at work, the signal lamp is in green light.**

**The green light indicates the safety situation and the laser machine is ready for operation.**

**If temperature is higher than 55°C/131°F on working table, the signal lamp will make buzzing sound (roughly 50dBA within 1m, 75dBA within 5m and 65dBA within 10m, the sound gets weaker as it travels).**

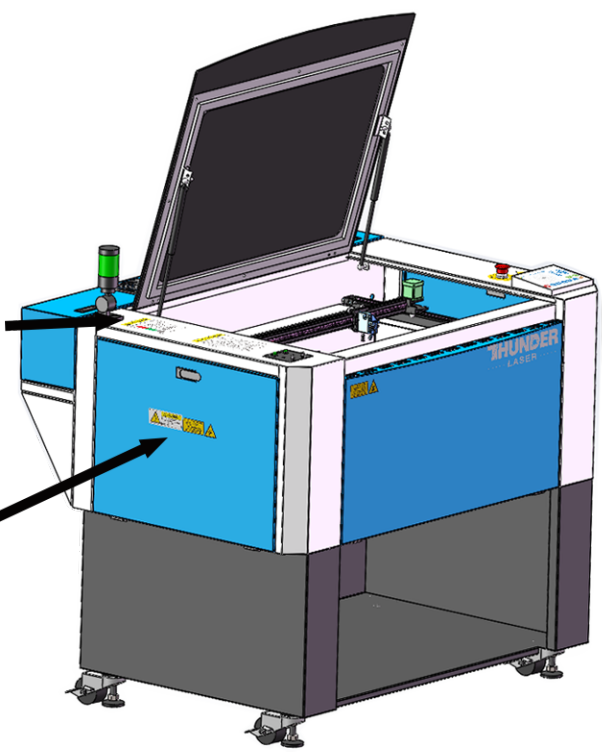

**CAUTION**

**Dangerous voltage!**  
Take care to avoid coming into contact with electricity!

**CAUTION - CLASS 4 INVISIBLE LASER RADIATION WHEN OPEN AND INTERLOCKS DEFEATED AVOID EYE OR SKIN EXPOSURE TO DIRECT OR SCATTERED RADIATION**



**EMERGENCY STOP**

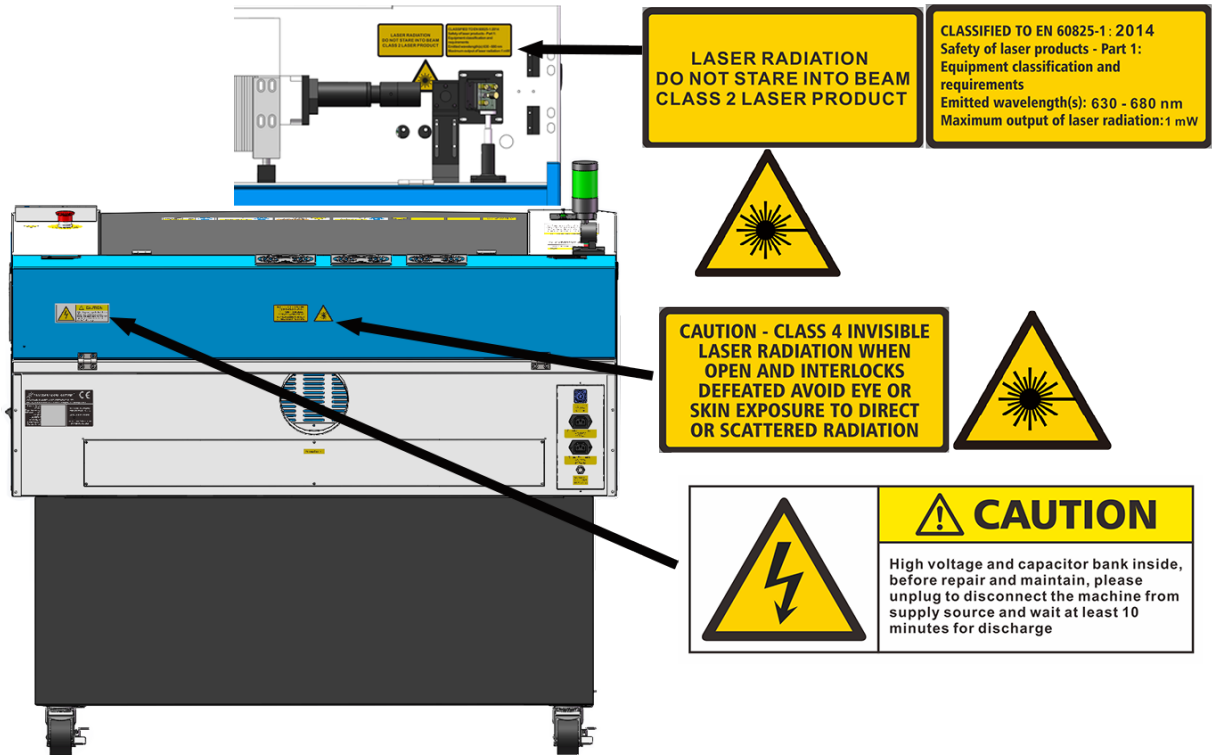

## Chapter 3. Process of Installing

### 3.1 Unpacking

You receive your THUNDER LASER ODIN SERIES packed in a wooden box which contains the laser machine and additional accessories. The following steps give you an overview of the unpacking and assembly of the laser. Please follow these steps carefully.



Keep the packing box. You will require it in case of a return.

Dispose all waste according to the applicable waste disposal law.

1. Put the wooden box on a flat and spacious room for unpacking.
2. Remove the machine box; carefully remove the protective foam, wraps, films, etc...
3. You will see an accessories box which contains all accessory parts required for the installation of the laser machine and check the contents carefully.
4. Remove the sponges and nylon cable ties from inside the machine, and then start to install the machine, carefully following the instructions in this manual.

### 3.2 Location

Before you install the laser system, you should select an appropriate location. Follow the guidelines shown below:



1. Avoid locations where the system is exposed to high temperatures, dust and high humidity. (The humidity must not exceed 70% and the temperature must not be close to the dew point.)
2. Avoid locations, where the system is exposed to mechanical shocks.



1. Circuit Breaker protection: Do not connect other devices on the same circuit as the laser system. It requires a dedicated circuit.
2. DO NOT open any of the machine's access panels while the unit is plugged in. Opening a panel may expose the operator to severe electric shock, invisible CO2 laser radiation, mechanical pinch points, burns, blindness, and other hazards. **ALWAYS POWER OFF AND UNPLUG!**
3. DO NOT make or break any electrical connections to the system while the unit is turned on.



1. Avoid locations with poor air circulation; select a location close to ventilation (if available). Select a location, whose room temperature is between 15 °C and 25 °C (59° – 77° F).
2. This is fundamental to maintain consistent and reliable operation of a CO2 laser, Metal RF or Glass tube and the machine itself. Avoid higher ambient temperatures and strong exposure of the engraver to the sun. Use blinds, if required.
3. Mechanical shock and vibration of the laser will have detrimental effects on the performance and life expectancy of the machine. It will manifest (over a period of time) with a noticeable decrease in performance and increased maintenance required, possibly even damage. Setting your Thunder Laser up in a suitable temperature controlled, dust free, moisture free, level, stable surface (a level concrete floor) with the recommended extraction is critical to the ongoing performance of the machine. It is also a warranty condition.



### 3.3 Before Installation

1. Remove the nylon cable ties around the honey comb plate.

Remove the transparent bag from the front of honey comb plate, like below:



The transparent bag has a set of USB flash drive, and an engraving test sample. The USB flash drive stores software, manuals, libraries, etc... that you will need.

Reverse Offset/Scan Offset compensation settings for this specific machine are included. **These settings need to be entered into your RDWorks and/or LightBurn settings to ensure the highest engraving quality.** Refer to the Ruida and/or LightBurn Manuals for these necessary procedures.

2. Rotate the E-Stop switch in the direction of the arrows to reset. Familiarize yourself with the emergency stop button's operation and location.





3. When you have the machine in its final position, please be sure to re-fix the feet in all four corners. Please see below:

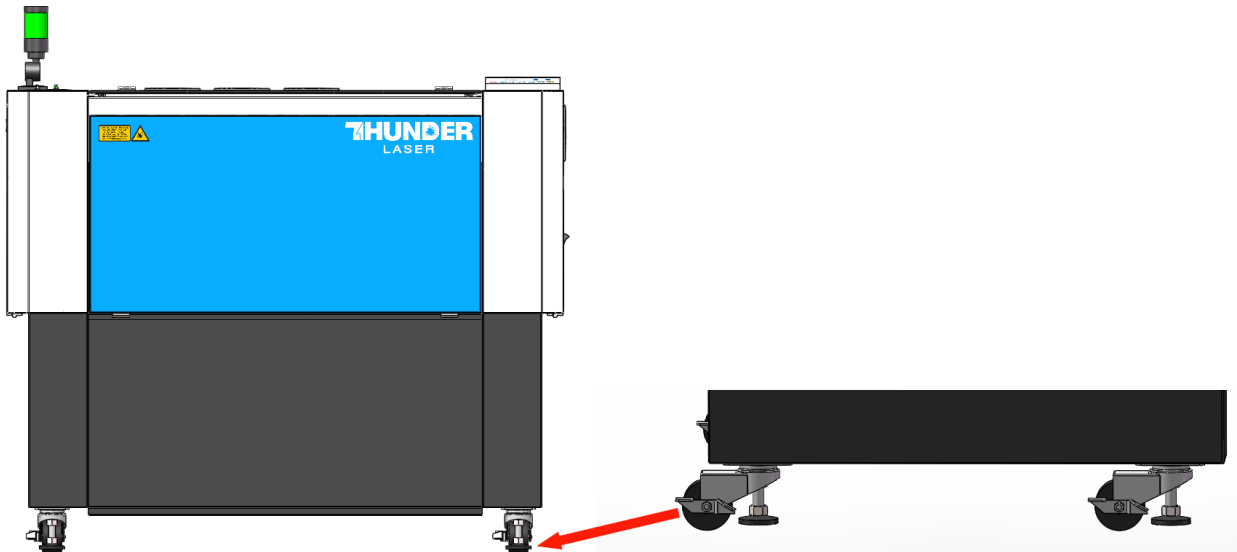

The main power cable is in the tool box that came with the machine.

### 3.4 Exhaust System – Requirements

Proper fume extraction is imperative to evacuate the combustible and noxious fumes that are created during the lasing process. This machine must be equipped with an adequate exhaust system. This includes a blower of rated flow, volume, and duty cycle as well as properly installed ducting and peripherals. You can further reduce smells from fine particulate matter with an inline filtering system.



Connection - see section 3.7.4 connecting the Exhaust System.



Do not start the machine without an adequate exhaust system.

### 3.5 Air System – Requirements

The included air pump supplies the dual stage air assist control and is a critical component. This helps keep the focusing lens clean and cool during the engraving process. Air assist is also critical when cutting to reduce flame-ups and clear the debris field.



Always use the system's Air Assist feature when vector cutting.

### 3.6 Computer – Requirements

The following recommendation represents the minimum requirements. When using a more powerful computer the graphics are generated and displayed faster and the computing times and the data transfer to the laser are reduced. To use the newest software version, you might have to abide other requirements.

- Windows 10 (32 bit or 64 bit )
- Windows 8 (32 bit or 64 bit )
- Windows 7 (32 bit or 64 bit )
  - Windows Vista (with Service Pack 1 or later)
  - Windows XP (with Service Pack 2 or later)
- 1024 MB of RAM, 400 MB of hard disk space
- Pentium® 3 or 4 processor or AMD Athlon™ XP
- 1024 x 768 or better monitor resolution
- 1 free USB interface
- 1 free Ethernet interface
- Mouse

These requirements are for RDWorks. LightBurn software renders jobs thousands of times faster than RDWorks. Check [LightBurnSoftware.com](http://LightBurnSoftware.com) for more information.

### 3.7 Connections



Perform the connections exactly in the order described; otherwise electrostatic charging can damage your computer and/or the electronics of the laser system.

#### 3.7.1 Connecting the Mains

Connect one end of the mains cable with the connection socket at the rear side of the laser device (see Figure below) and the other end with a protected power outlet.

Mains voltage and operating voltage must correspond (AC 115V 50/60 Hz or AC 230V 50/60 Hz) – see information label beside the connection socket.



Under no circumstances should you switch on the device if the voltages do not correspond.

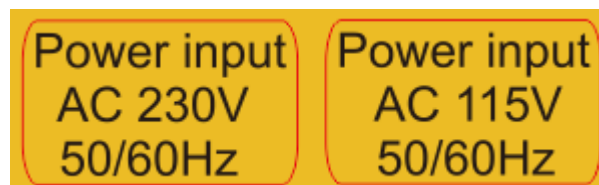
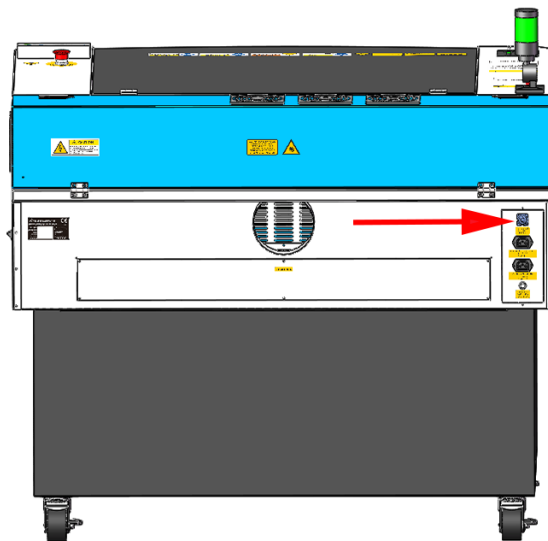



The mains cable is placed in the toolbox.

### 3.7.2 Connecting the Computer

Connecting the Computer and the machine by using the USB cable. Like below:



Connecting the Computer and the machine by using the Ethernet cable. Like below:

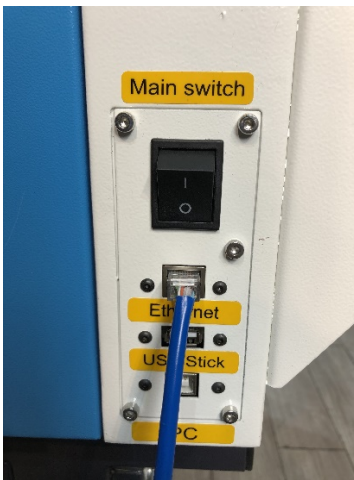

The USB and Ethernet cable are placed inside the toolbox.

### 3.7.3 Connecting the Air System

First of all, install an air blowing mouth (copper) to the air system, then connect the hoses (white side) to the mouth, the other side to the machine. After that, please connect the power cable (of the air system) to the machine. Like below:



A customized anti-shock foam that came with the air pump can be placed under the air pump.

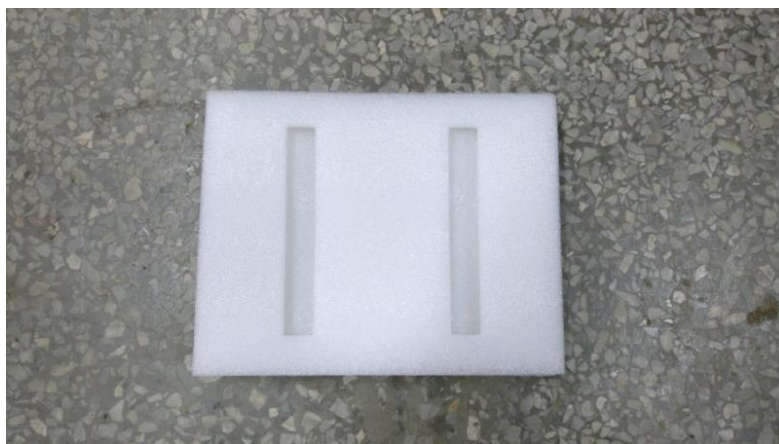

The input voltage must correspond (AC 230V 50/60 Hz or AC 115V 50/60 Hz) – see information label beside the connection socket.

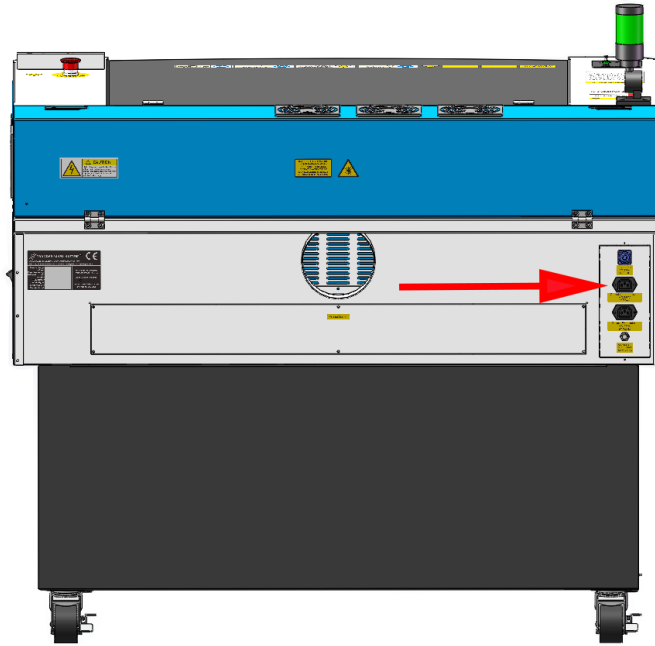

Output: Air compressor AC 230V 50/60Hz	Output: Air compressor AC 115V 50/60Hz
--	--



### 3.7.4 Connecting the Exhaust System

How to set up the exhaust system

Insert one side of the gray exhaust pipe into the fan inlet and the other side into the fuselage behind the exhaust tank. Insert one side of the gray exhaust pipe into the fan outlet and put the other side of the pipe outside where you work (If the machine is far from the outside of the room that the gas manufactured by the machine cannot be discharged; then you might need an dust/fume filter, it can keep the air quality of your working environment well).

Please refer to the following pictures about how to install the exhaust pipe:

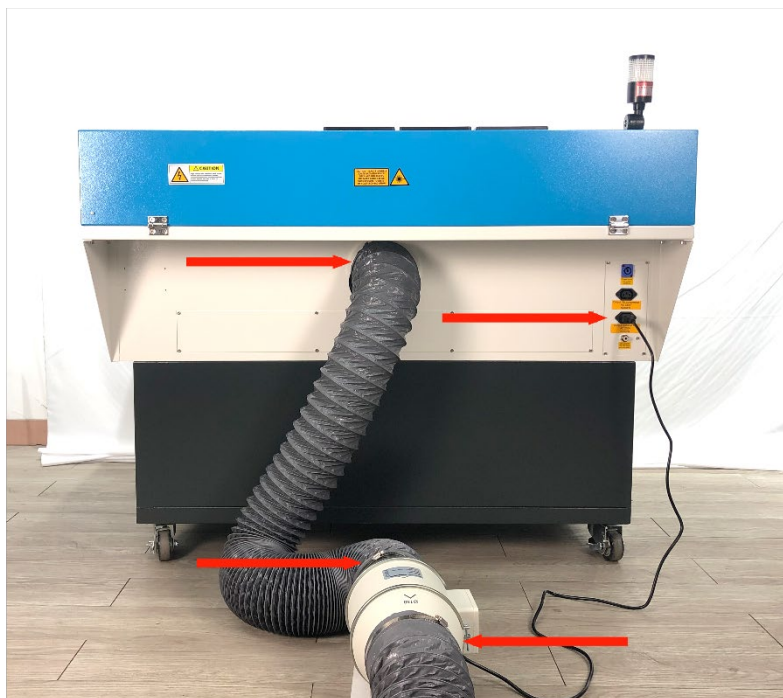

Also you can refer to the video on how to set up your Odin laser machine in our website

<https://youtu.be/97cs3xWeUMA>



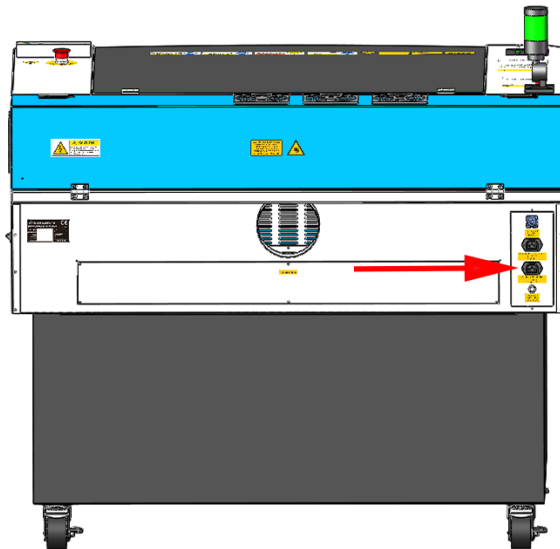

The input voltage must correspond (AC 230V 50/60 Hz or AC 115V 50/60 Hz) – see information label beside the connection socket.

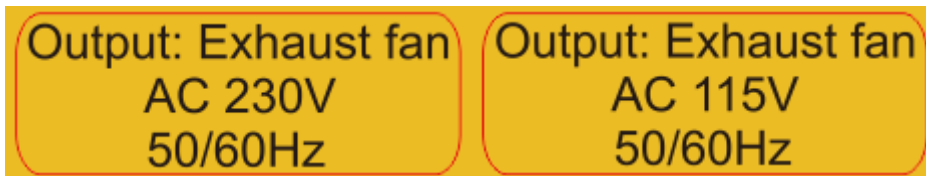

Do not connect the air compressor or the water chiller to the above interface, if connect them to the above interfaces that cause in failure of the machine, the warranty does not were covered.

## Chapter 4. Operation

### 4.1 Machine View

#### 1. Top flap

If the Top flap is opened, no data is processed. When the protection cover is opened during working, the motion system is stopped and the laser source is turned off. During processing of commands the protection cover must only be opened after pressing the "Pause" button.

#### 2. Laser head

Laser beam and red dot pointer are all come out from the laser head.

#### 3. Honey comb table

The honey comb plate sits on top of the blade bed and has indexing pins for alignment.

#### 4. Indicate light

If laser machine is running a job or user starts it without closing door or water protection, the signal lamp is in red light. The red light indicates the dangerous situation and user must stay with the laser.

If laser machine is not at work, the signal lamp is in green light. The green light indicates the safety situation and the laser machine is ready for operation.

If temperature is higher than 55°C/131°F on working table, the signal lamp will make buzzing sound. (roughly 80dBA within 1m, 75dBA within 5m and 65dBA within 10m, the sound gets weaker as it travels).

#### 5. Dual air-assist control panel

You can adjust air volume for cutting or engraving if require. (Please view this chapter 4.9 for detail).

#### 6. Left side door

On odin22, there are installed the TL-Timer board, Z-axis Motor, Flap sensor checking board etc. Please open this door for checking these parts, but must pay attention to the electric current.

#### 7. Foot stand

Moving or fixed the laser machine.

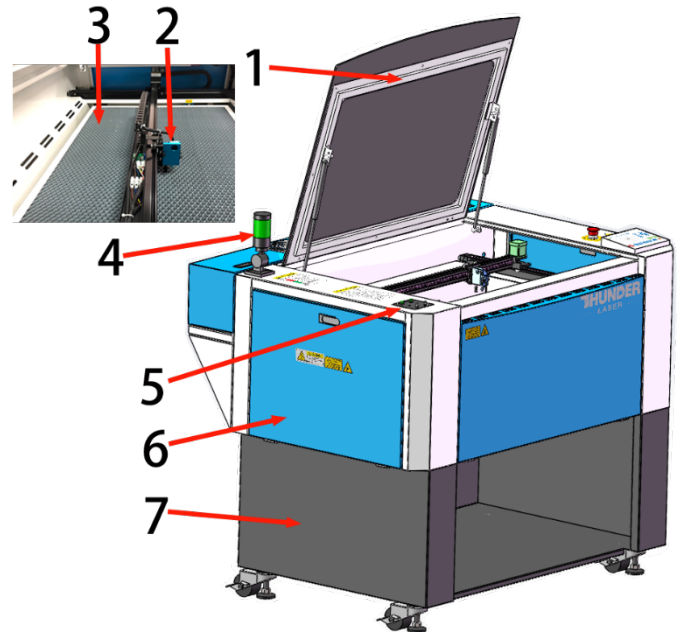

### 8. Front door

To clean the waste after working or remove the honey comb table. This door is installed with the flap protection sensor.

### 9. X axis

The motion system is that performs the mechanical movements in X direction. The X-axis is visible in the working area.

### 10. Y axis

The motion system is that performs the mechanical movements in Y direction. The Y-axis is visible in the working area.

### 11. LCD panel

You can control the X-axis, Y-axis and Z-axis manually by the display panel, it also shows the working time, power, speed and the whole working time and affords many function options (Please view this chapter 4.3 for detail).

### 12. Flap protection sensor

This is where Open flat protection exist. Laser will stop working once the cover is opened during working.

### 13. Emergency stop switch

Once there's an accident happen (laser catch fire, laser out leakage) during working, please turn off this switch immediately. It will be cut off the laser power and motion power immediately.

### 14. Auto-focus sensor

Used for the automatic focusing of the work table.

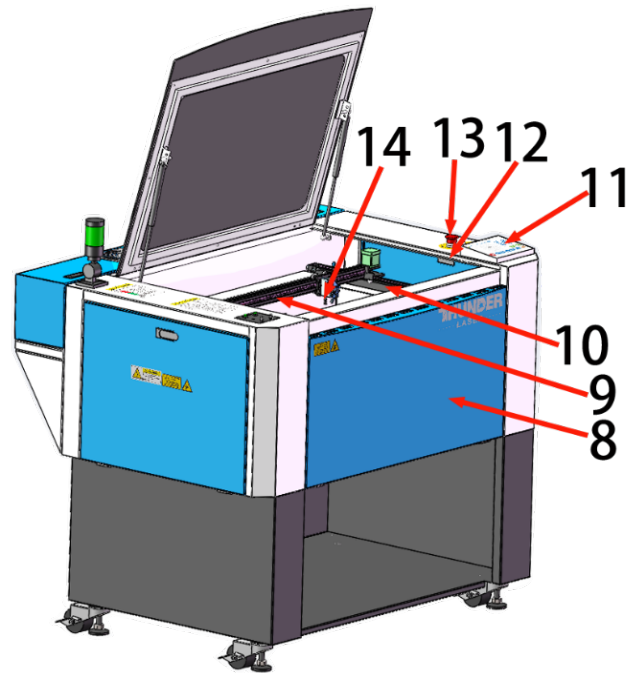

**15. LED lamp**

It's used for lighting the working table once turn the Main switch on.

**16. Right door**

On odin22,32, there are laser controller, drive (5 phase open-loop motor driver and Stepper Drive ), power supplier(24V&36V) etc.

Please open this door for checking these parts, but must pay attention to the electric current. If you need to repair, please contact with professional maintenance staff.

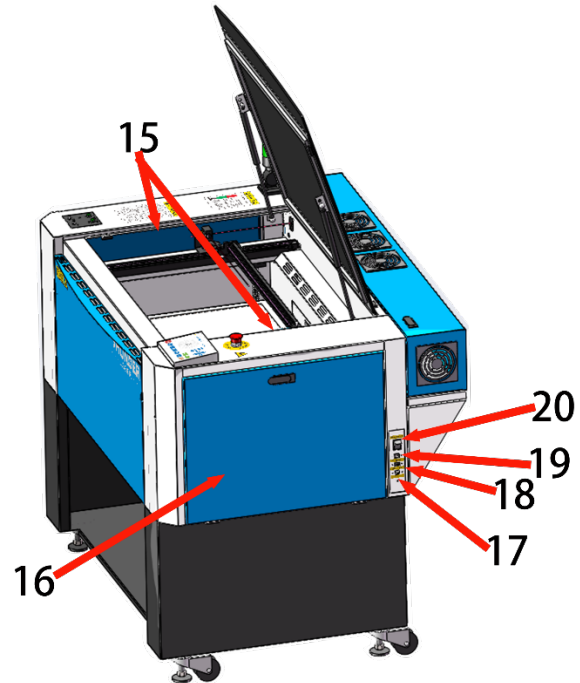
**17. PC connection port(USB)**

This USB is for connecting computer.

**18. U-disk connection port(USB)**

You can save the file as a U-disk File by press "SaveToUFile" on the software, then save it to the u-disk and insert the u-disk to the port of laser machine, then use the control panel to select and control it to work.

**19. Ethernet port**

This Ethernet port is for connecting computer.

**20. Main switch**

The laser machine will be start while you turn it on.

**21. Cooling fan**

Radiating the RF tube.

**22. Exhaust hose**

This is for installing the exhaust device.

**23. Laser tube cover**

There are installed the laser tube, red dot pointer device, beam combiner and the first reflective mirror mount. This door is installed with the flap protection sensor.

**24. Manufacture's Label**

It's Show you the laser information like serial number or manufacturing date etc.

**25. Blow air port**

This port is for connecting hoses of the air compressor.

**26. Laser supply socket**

To connect the main power and the extend power according the label information.

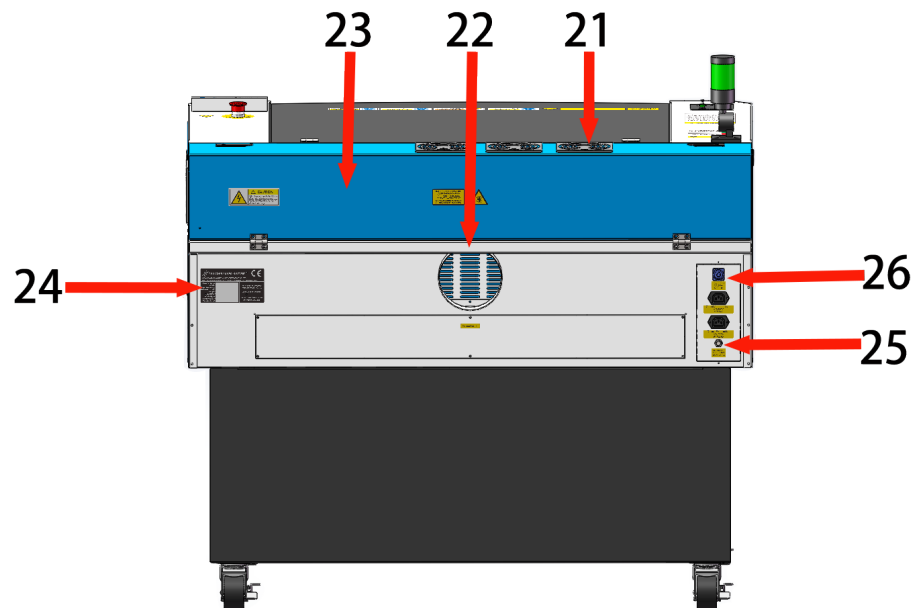

## 4.2 ON/OFF Switch

The mains and the laser supply power ON/OFF switch

The following conditions must be fulfilled for correct start up:

Unrestricted freedom of motion of the mechanics

No materials under the engraving table

Protection covers closed

Then turn the Main Switch on

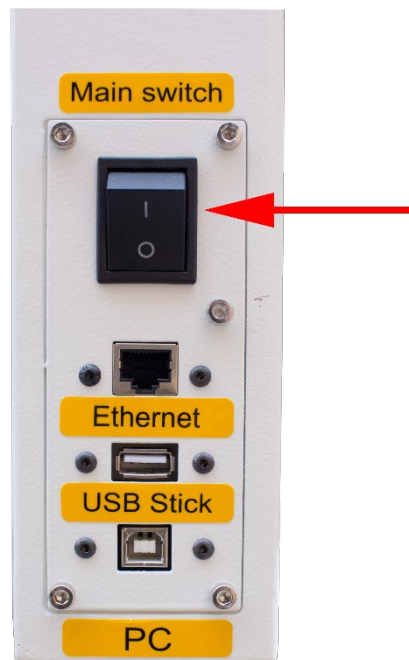

If all covers are closed, immediately after being switched on, the device starts the referencing process. When the referencing process is completed correctly, an acoustic signal sounds and the device is ready for operation. The operation panel will display the home screen when the laser is completed resets.



Before switching on the device, the user must make sure that no objects of any kind are located inside the operating space, which could limit or obstruct the mechanics of the device.

### 4.3 How to setup the OEM software

**PLEASE VISIT LIGHTBURNSOFTWARE.COM TO FIND RESOURCES FOR INSTALLING LIGHTBURN**

#### 4.3.1 Software installation

Your machine comes with a USB flash drive, which you will find many helpful application videos and instructions as well as the software for your machine.

To install the software, insert the USB flash drive into your PC and open the "Software" folder on the USB flash drive.

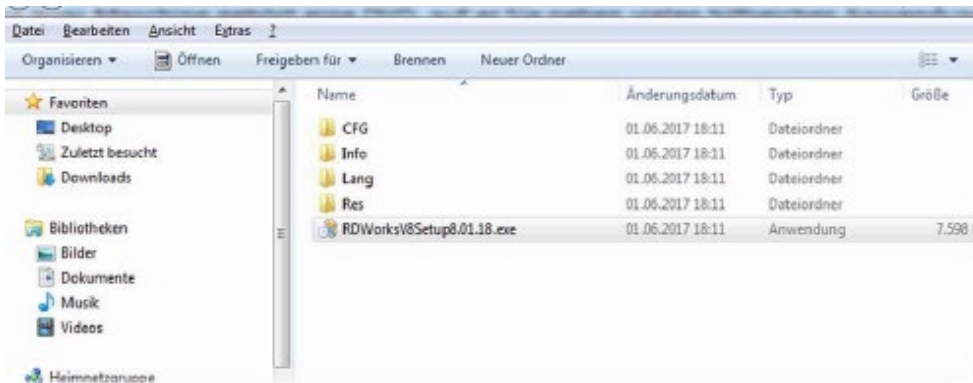

In this folder you will find the installation file "RDWorksV8Setup8.01.50.exe". Run this file by double-clicking on your PC.

Follow the installation menu until the window "Welcome to use" opens, like below.



If you use USB cable connection, please install the USB driver.

The type of the program offers different possibilities:

1. LaserWork: If you select this option, the laser software RDworksV8 will be installed on your computer.
2. CorelDraw\_Laser: If you work a lot with Corel Draw, you can transfer your images and drawings directly to RDworksV8.

How to install the coreldraw plugin for RDworksV8, click below link for instruction

<https://www.thunderlaser.com/troubleshooting/software-problem/how-to-install-the-coreldraw-plugin-for-rdworks.html>

[www.thunderlaser.ca](http://www.thunderlaser.ca)  
[sales@thunderlaser.ca](mailto:sales@thunderlaser.ca)

Tel: +1403-814-9808

3. AutoCAD\_Laser: Select this option to install a plugin that can transfer the drawings directly from AutoCAD to RDWorksV8.

4. EngraveLab\_Laser: Select this option and install a plugin that can transfer the drawings directly from EngraveLab to RDWorksV8.

Origin (zero point): This is specified by the machine and must always be selected "top-left" for Thunderlaser machines.

Size unit: Here you can choose between millimeters and inches.

Select installation path: Here you can select a different installation directory for your laser software. We recommend that you use the default settings, otherwise some operating systems may restrict the functionality of the software due to misinterpreted access rights.

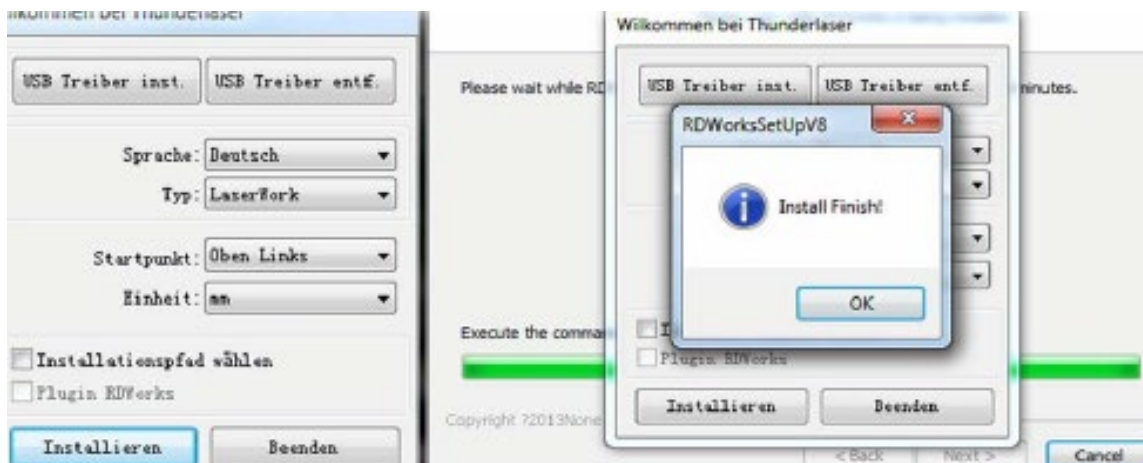

After selecting your options, click "Install" and then brings up a window "Install Finish!". You can confirm this and then end the installation process.

A "RDWorksV8" icon will be automatically added to your Desktop, you are now ready to use the RDworksV8.



Trouble shooting for RDworks installation.

If you were unable to install the RDworks, it's possible that your Anti-Virus software is blocking installation.

Please disable all Virus and Spyware Protection Features. After the RDworksV8 has been installed go back into your Anti-Virus software and re-enable the setting that was disabled.



**4.3.2 Make connection between PC and machine**

- USB cable connection

Make sure that you have the USB driver installed during the installation process.

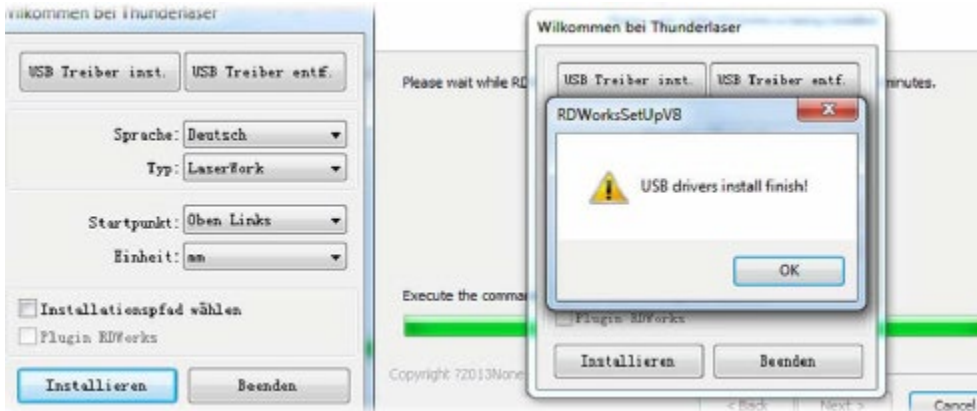

Make sure that you have your PC connected to the machine via USB cable,

Open RDworks, from right bottom corner of the software, set up the Device by Setting>>Device --- (USB: Auto).

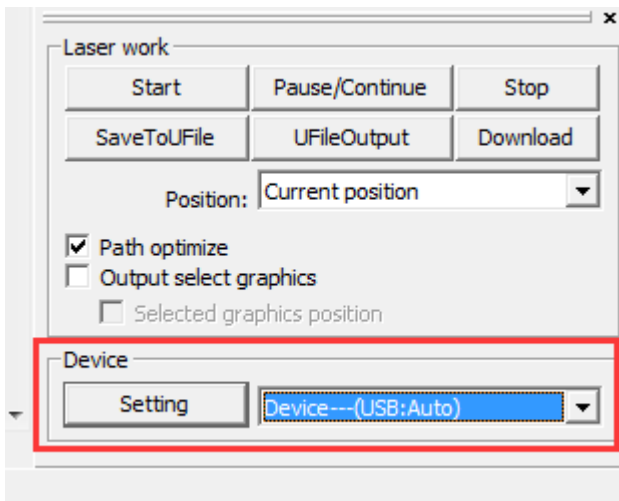

Your PC is now connected to the machine.



When connecting the machine and the PC for the first time, it may take a few minutes for the operating system to recognize the machine and install the driver.

- Ethernet cable connection

Make sure that you have your PC connected directly to the machine via Ethernet cable,



The machine is already assigned an IP address when delivered: 192.168.1.100

Now set up your PC so that it is in the same network and can communicate with the machine.

Please follow the instructions below for the setup process (For Windows7):

- 1) Click Windows Start > Control Panel.
- 2) Click **Network and Internet > Network and Sharing Center**. In the left pane, click **Change adapter setting**.

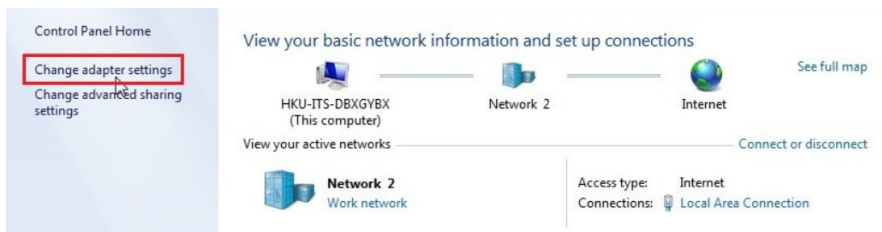

- 3) Right click **Local Area Connection** and then select **Properties**.

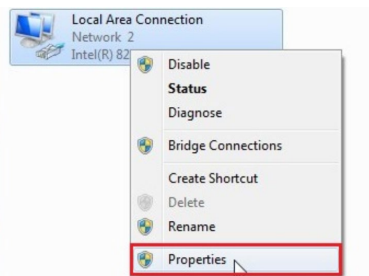

- 4) Under **Networking** tab, choose **Internet Protocol Version 4 (TCP/IPv4)** and then click **Properties**

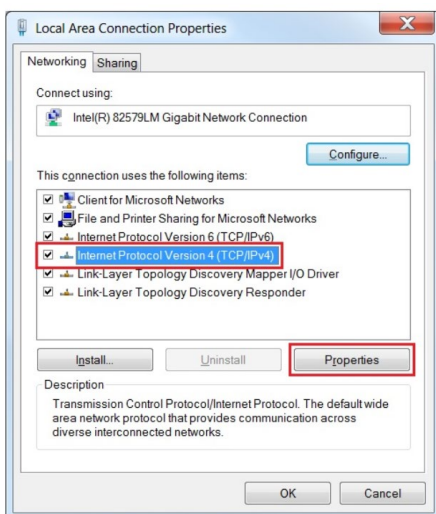

5) In "Internet Protocol Version 4 (TCP/IPv4) Properties" window, select "Use the following IP address:"

Type IP Address: 192.168.1.1

And Type subnet mask: 255.255.255.0

Then click OK.

With this you have successfully created the prerequisites so that the machine and the PC can communicate via LAN.

Now open your RDWorks from right bottom corner of the software, set up the Device by Setting>>Device --- Add a "Device---(IP:192.168.1.100)".

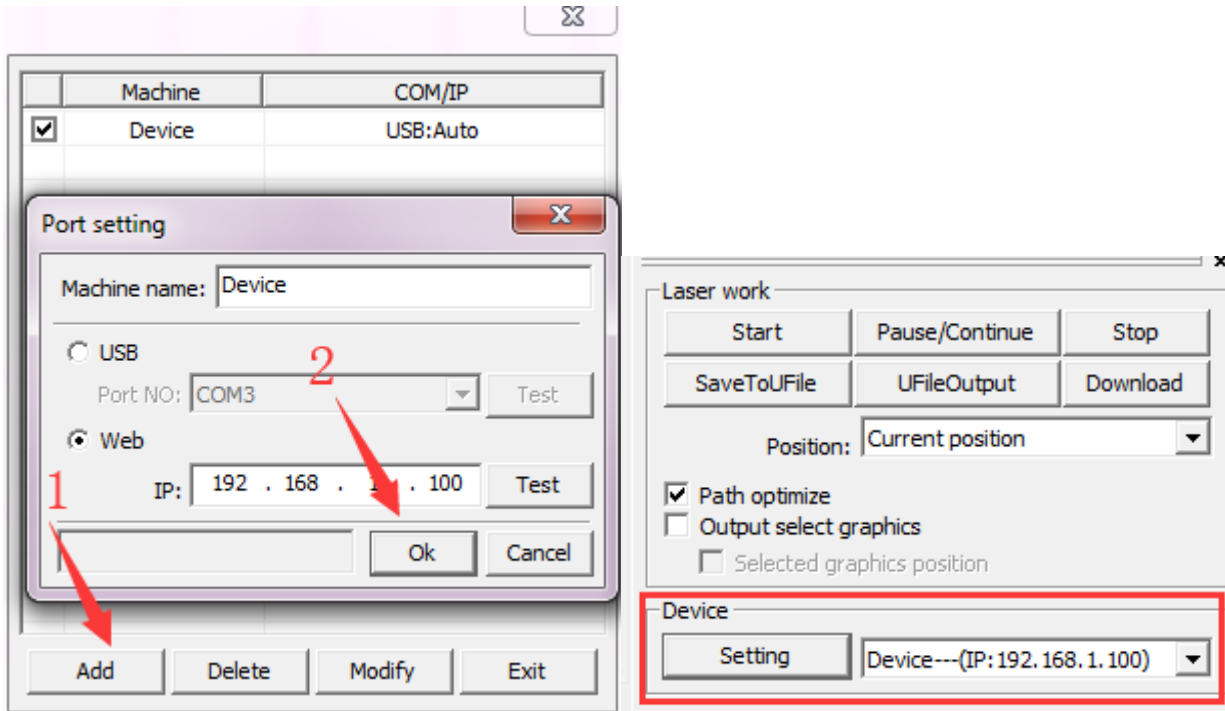

Now RDWorks communicates with your laser machine via LAN.

## 4.4 How to use the display

### 4.4.1 Function of the Buttons

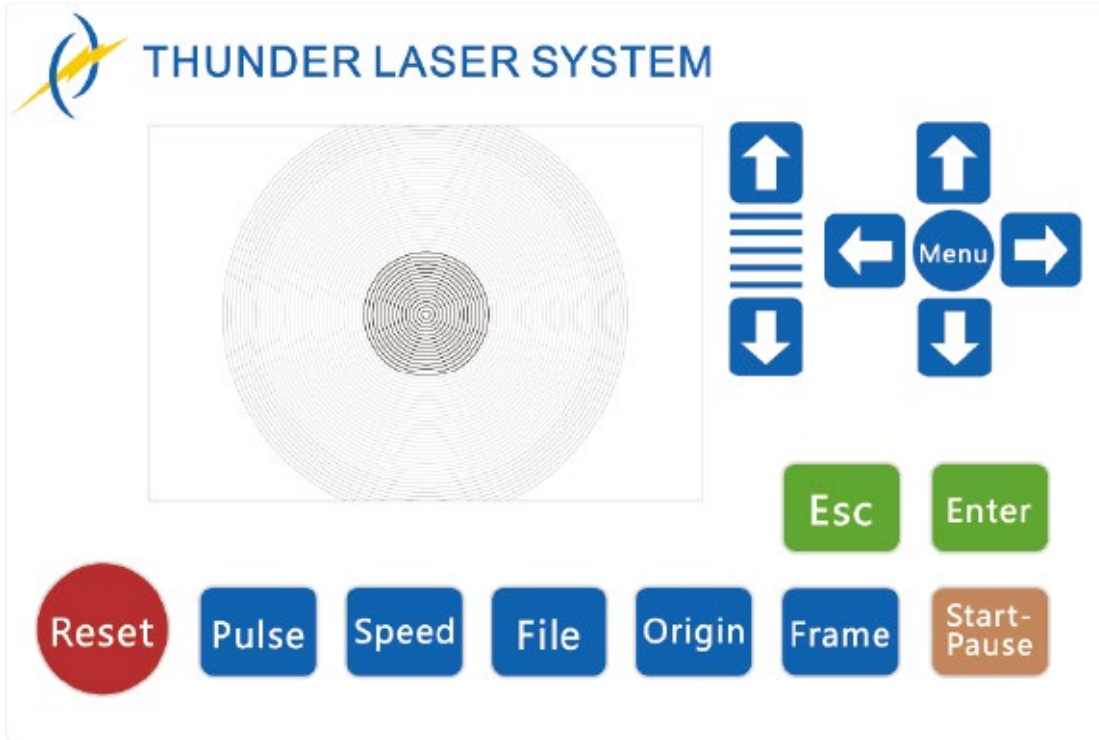

✧ Arrow buttons: control the movement of the Z-axis.



✧ Arrow buttons: control the movement of the laser head.(also can be used to change the parameters in the control panel)



✧ Menu button: The Menu key can be pressed when the system is idle or the work is finished. On pressing this key, it will show some entries in the interface, each entry includes some functions, U axes move, each axes to go home etc.



- ✧ Reset button: Reset the machine.



- ✧ Pulse button: Pulse a laser beam.



- ✧ Speed button: Set the speed of the current running layer, or *set the arrow buttons' move speed.*



- ✧ File button: The management of the memory and U disc files.



- ✧ Start-Pause button: run/pause the current job.



- ✧ Origin button: set the starting point for the laser head.



- ✧ Frame button: To track by the current file's frame.



- ✧ Esc button: To stop work, or return to the last menu.



- ✧ Enter button: confirm your selection.

### 4.4.2 The main interface

When the system is powered on, the screen will show as below:

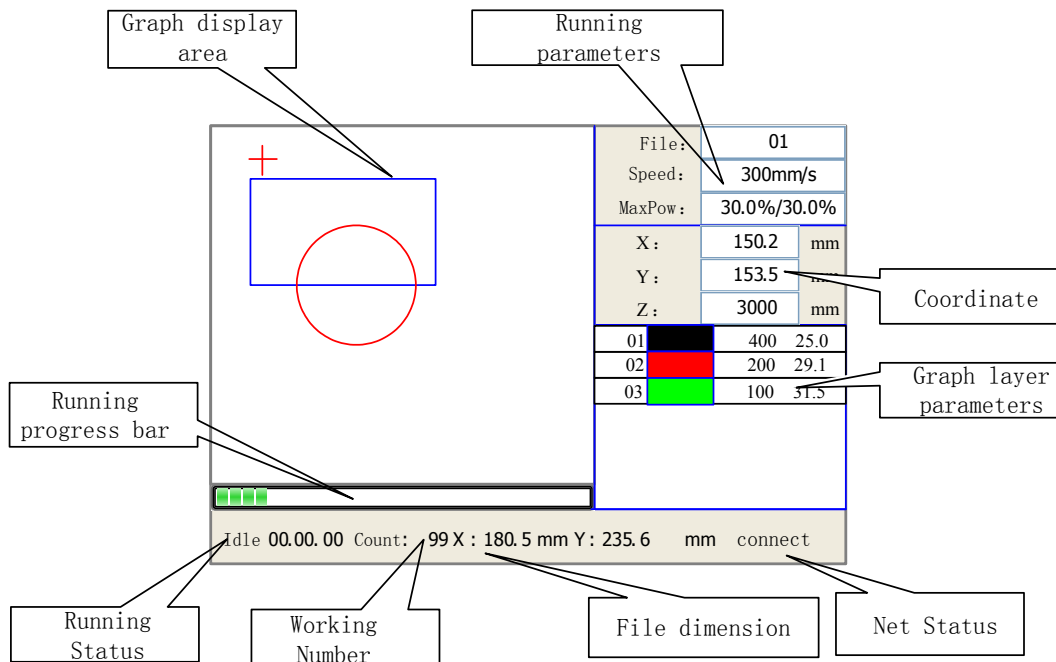

- Graph Display Area: To display the whole file's track, and display the running track.
- Running parameters: To display the running file's file number, speed, max power etc.;
- Coordinate: To display the current coordinate of X,Y and Z axes
- Graph layer parameters: To display the layers' information of the current file, such as max or min power, speed etc. When system is idle, double-click the layer, then users can change the layer's parameters and the changing would be saved.
- Running Status: To display the current status of the machine, such as Idle, Run, Pause, Finish, etc.;
- Running Progress Bar: To display the progress bar of the current running file;
- Working Number: To accumulate the work number of the current file.
- File Dimension: To display the dimension of the current file;
- Net status: To display the connecting status of the Ethernet.

When work is Idle or finished, all buttons can be clicked, users can select a file to run, set some parameters, preview to a select file etc. But, when work is running or paused, some buttons don't respond when they are clicked.

#### 4.4.3 Speed button

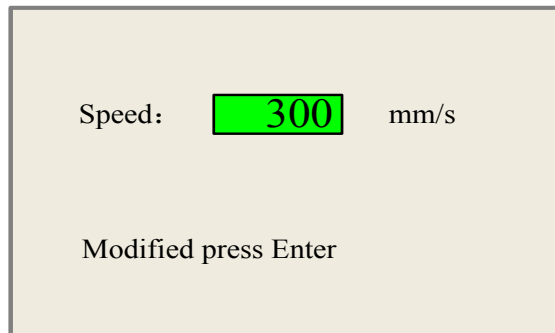

The speed can be set from 1~2000mm/s.

#### 4.4.4 Max Power buttons

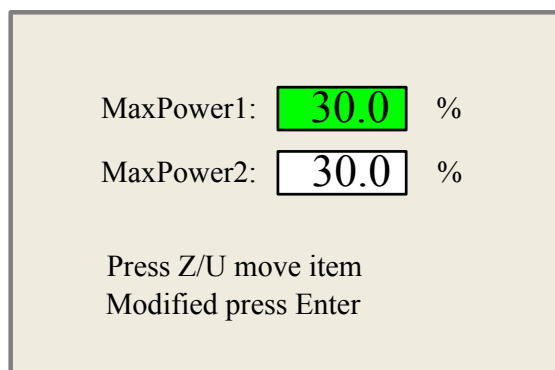

The max power can set the power for pulse button to shoot the laser beam, and max power2 is only for the double laser tube machine.

#### 4.4.5 Set the Layer Parameters

After selecting a file to preview on the main interface, user can click "Enter" button to modify the parameter for the file from the machine.

01		400	25.1
02		200	29.1
03		100	31.5

Layer0:

Speed:  mm/s

MinPower1:  %

MinPower2:  %

MaxPower1:  %

MaxPower2:  %

Press Z/U move item  
Modified press Enter

**4.4.6 Menu button**

The Menu button can be pressed when the system is idle or the work is finished. On pressing this button, it will show some entries in the following interface:

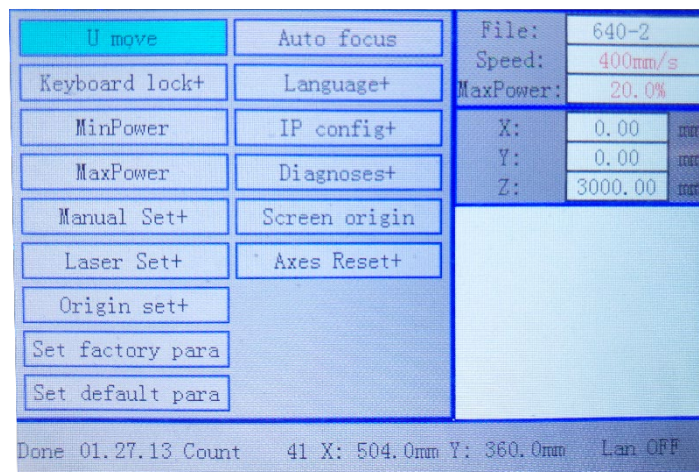

- U Move: When the green block is on “U Move” item, to control the rotary attachment to turn by pressing left and right arrow button.
- Axis Reset+: When the green block is on this item, you can manually reset the axis if needed.
- Set default para: To recover all manufacturer parameters and user parameters for your machine
- Auto Focus: To use the auto focus function.
- Language: The item “Language” helps you to select a appropriate langue which is displayed on



the panel:

- IP Setup: The machine is already assigned an IP address as 192.168.1.100, and the IP address on software should be the same while communicate
- Diagnoses: the “Diagnoses” interface shows some system input information, such as limiter status, the status of the water protecting, and the status of the door protection etc.

**4.4.7 File button**

**1). Memory File**

On the main interface, if “File” button is pressed, it will show as below:

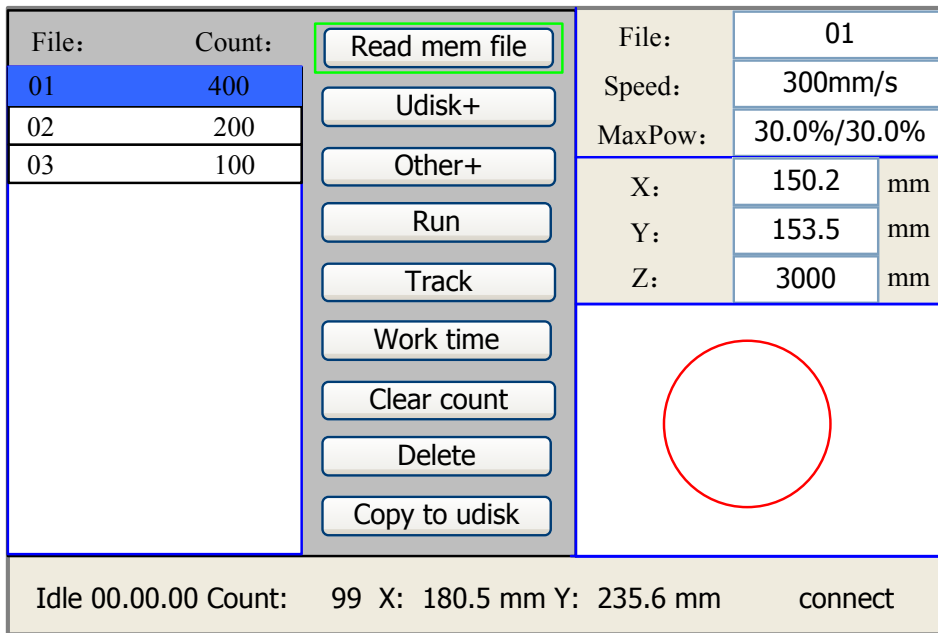

When showing this menu, the system would read the memory file firstly, the file name and the work times would be listed in the area, and the selected file is previewed in the bottom right area. “Y+/-” keys could be used to move the cursor on the file name list. When the cursor is on a target file name, presses the “Enter” key, the selected file will be previewed on the main interface, and then if “Esc” key is pushed, the preview will disappear.

“X+/-” keys could be used to move the cursor left and right. All the item show as below:

- **Read mem file:** read the memory file list;
- **Udisk:** read the U disk file list;
- **Other:** the other operation of the memory files;
- **Run:** To run the selected file;
- **Track:** To track the selected file, and the track mode is optional;
- **Work time preview:** To forecast the running time of the selected file, and the time is accurate to 1ms;
- **Clear count:** To clear the running times of the selected file;
- **Delete:** To delete the selected file in the memory;
- **Copy to Udisk:** To copy the selected file to Udisk;

If the “Other” entry is pressed, the system will show as below:

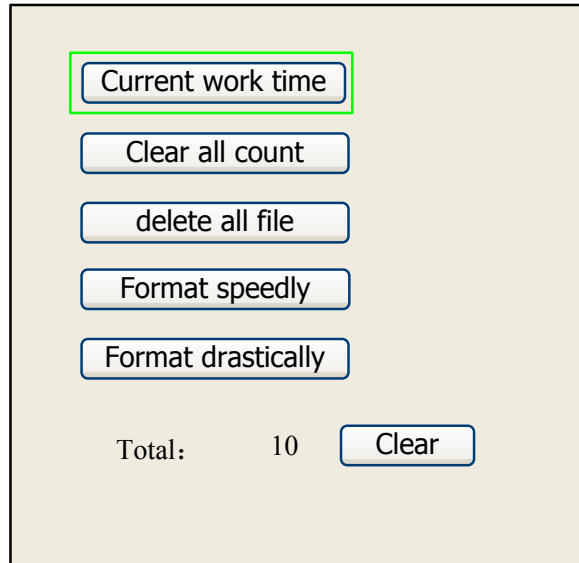

- **Current work time:** To forecast the running time of the current file(the current file No. is showed on the main interface), and the time is accurate to 1ms.
- **Clear all count:** To clear the running times of every file in the memory
- **Delete all file:** To delete all memory files
- **Format speedily:** To format memory speedily, and then all the files in memory will be deleted.
- **Format drastically:** To format memory drastically, and then all the files in memory will be deleted.

**Total:** the total running times of all the files.

**2). U-Disk File**

If the “U-disk+” entry is pressed, you can copy your file from USB flash drive to your machine.

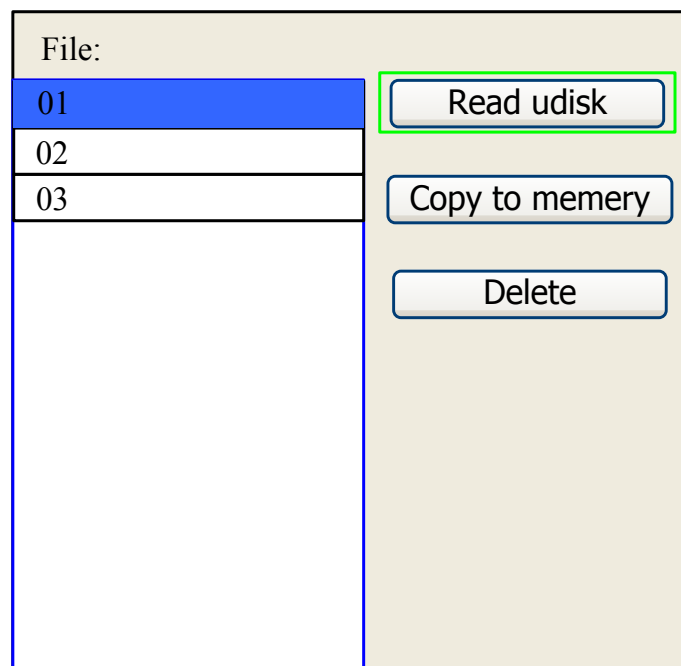

- **Read U disk:** read the file list in the U disk;

- **Copy to memory:** copy the target U disk file to the memory;
- **Delete:** delete the selected U disk file;



The controller can only compatible with USB 2.0 and at most 16G USB flash drive. For USB flash drive, you can use the one came with the machine to copy the file to your machine

The file should be .rd file and it's created by the "SaveToUFile" key on the RDworks.

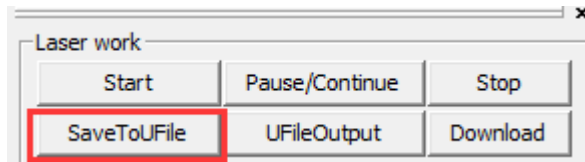

## 4.5 How to adjust focus distance by manual or auto

### 1) How to adjust focus distance by manual

Find the Focus Tool for help to adjust the focus directly like below:

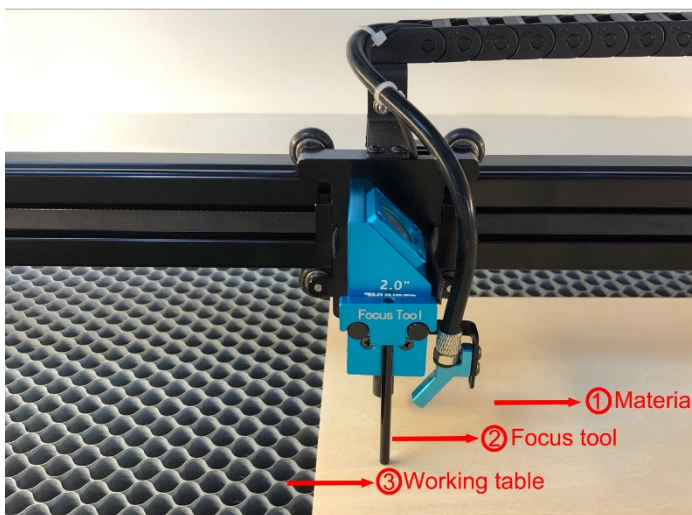

- ① Material
- ② Focus Tool
- ③ Working Table

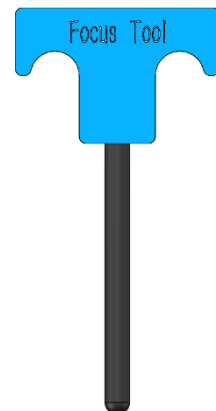

The focus length for all lens(1.5",2", 2.5"&4") are the same, just need to using this focus tool.

### 2) How to adjust focus distance by Auto-focus tool

Auto focus function can move up and down the working table to make sure the most proper distance between the material and the focal lens.

By using the auto focus function, users can focus quickly and accurately before cutting and engraving which saves the time of cutting and engraving and brings the better cutting engraving result.

1. The position of the autofocus tool is shown in the picture below:

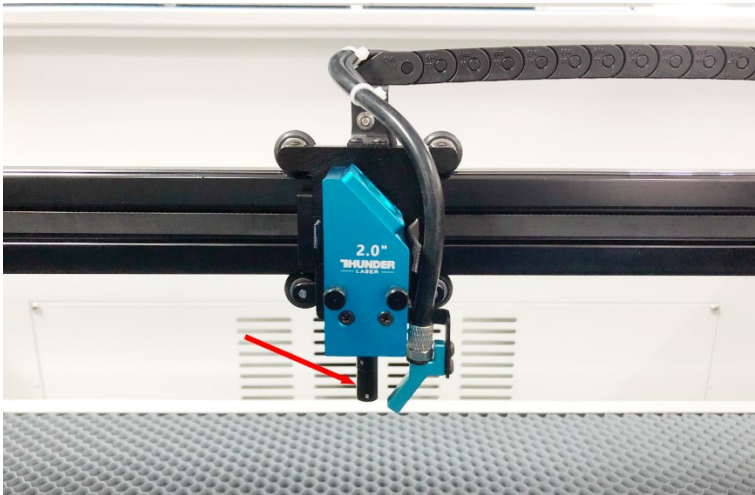

2. Please follow the steps below to use the Auto focus function  
 Move table down till there's enough space>>Place the material on the table>>Move laser head over the material>> go into Menu button>>Select Auto Focus.  
 After that, the needed focus will be set automatically.

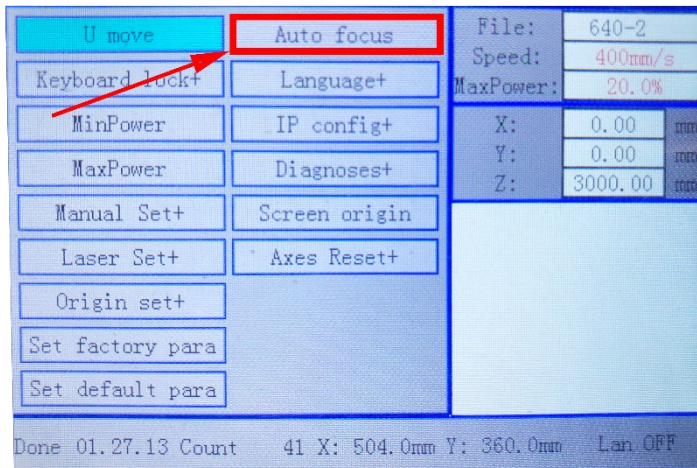

## 4.6 How to use the different optional lens(1.5", 2.5" & 4")

1.5", 2.5"&4" lens are optional item.

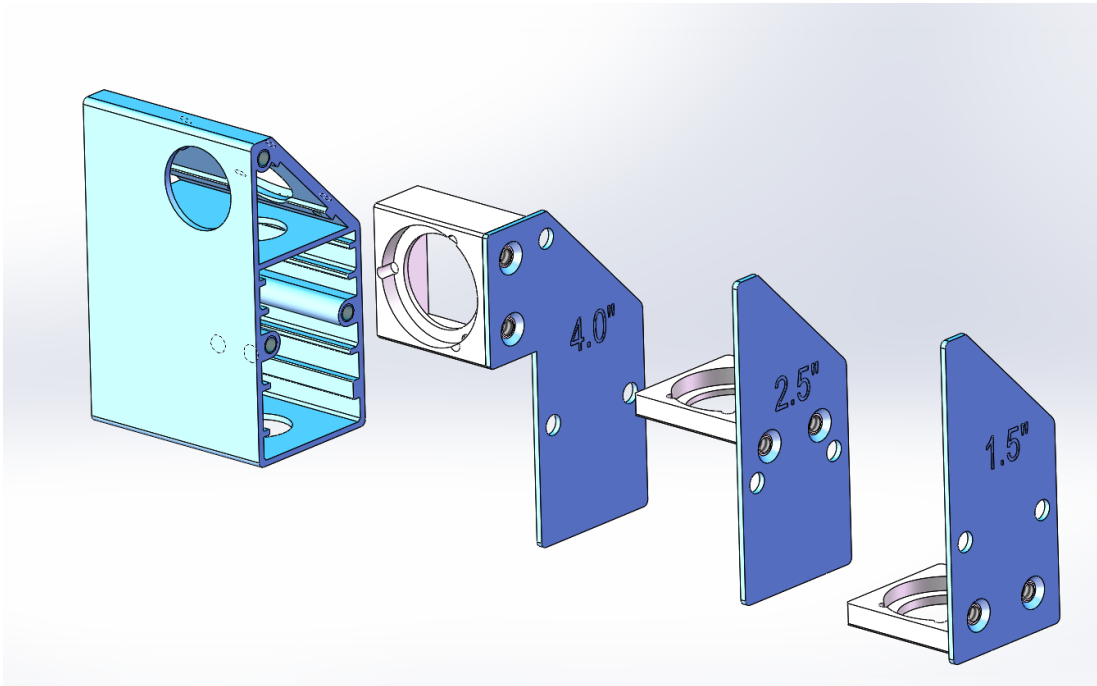

For different lens, the installation positions are different.

### 1.5" lens

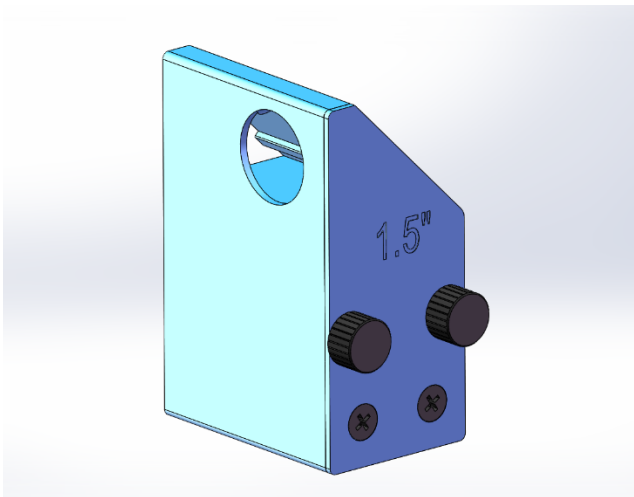

**2.5" lens**

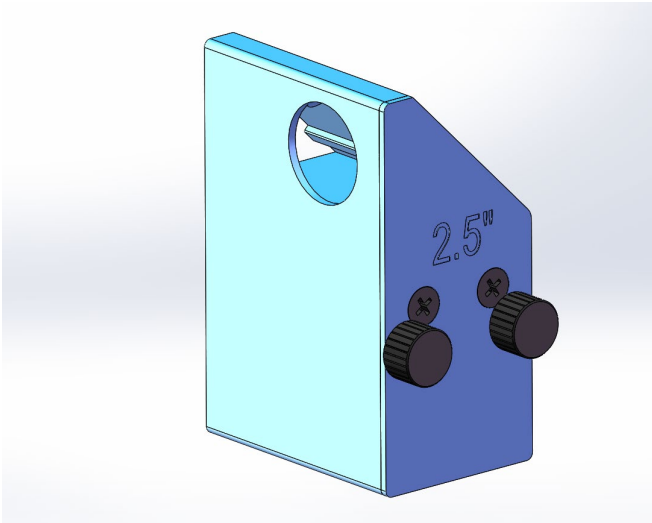

**4" lens**

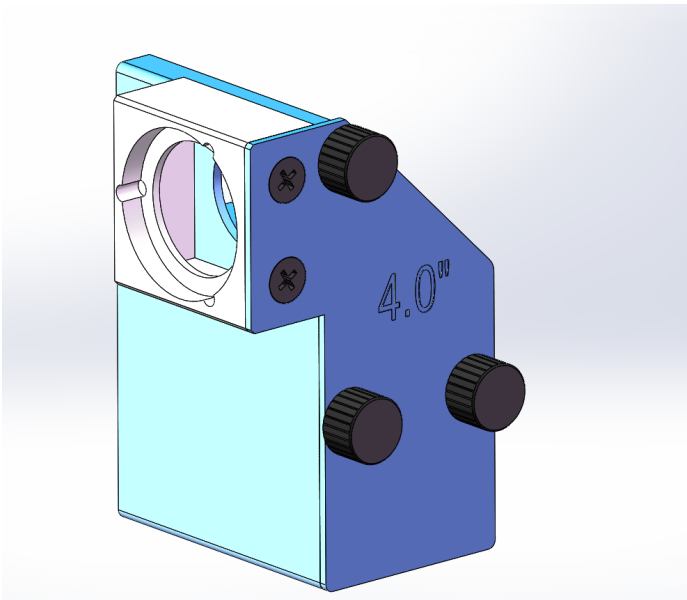



## 4.7 How to use the TL-Timer

The TL-Timer is an additional tool for laser machines.

It will control laser machines periphery like air pump, exhaust fan, warning lights, heat alarm detector, electrical locks and lot of other stuff automatically.

This will increase the ease of use of your laser machine.

Please note the different types of connection, which makes the TL-Timer able to work with each kind of laser controller.

### About TL-Timer controller interface and buttons description:

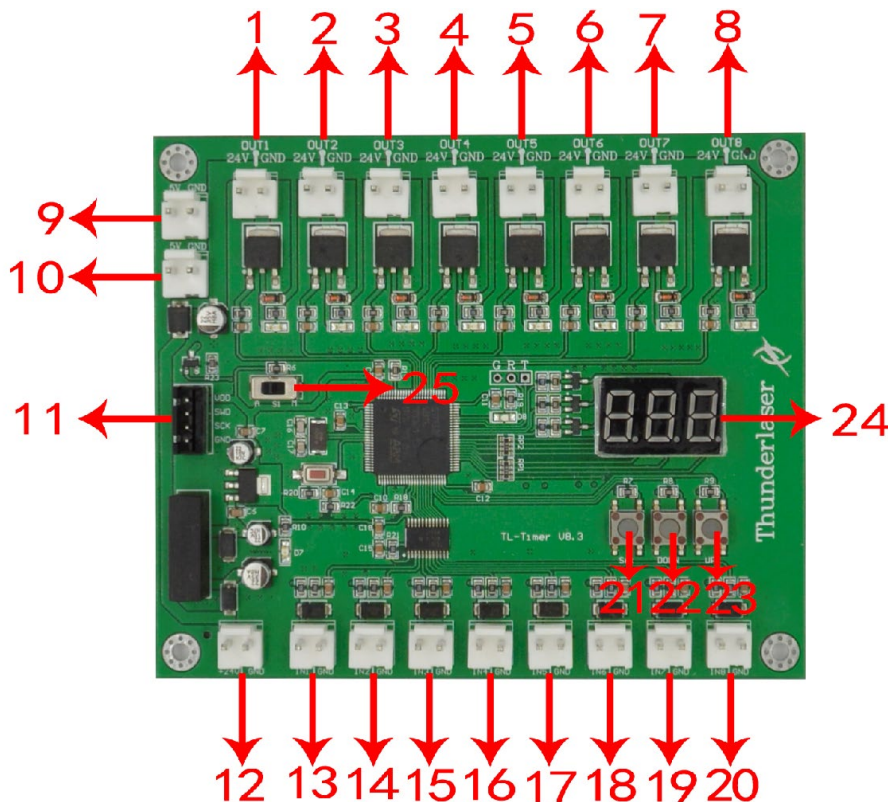

1. OUT1: Control the green light of warning light; When the machine is not at work, the warning light is in green color;
2. OUT2: Control the red light of warning light; When the machine is working or getting around alarm message on LCD panel, the warning light turns red;
3. OUT3: Control the exhaust fan; Delay shutdown is set to 30 seconds (Factory default settings, change it if required);
4. OUT4: Control air assist with “Low volume”; Delay shutdown is set to 20 seconds (Factory default settings, change it if required)
5. OUT5: Control air assist with “High volume”; Delay shutdown is set to 20 seconds (Factory default settings, change it if required);
6. OUT6: Control the fire alarm system; When A high temp is detecting on working area, the alarm system will be active, the warning light alarms and the machine stops working immediately;
7. OUT7: Control the power for rotary device;
8. OUT8: Spare interface;

9. 5V DC Voltage Power Output 1, control the power for red light pointer.
10. 5V DC Voltage Power Output 2, spare interface;
11. Upgrade interface;
12. 24V DC Voltage Power Input;
13. In1: "Working state" interface
14. In2: Spare interface;
15. In3: Air-assist mode selection;
16. In4: Control air assist with "Low volume";
17. In5: Control air assist with "High volume";
18. In6: Temperature detection
19. In7: Rotary connection state detection
20. In8: Spare interface
21. "Set" button, select each "OUT" interface and confirm the setting;
22. "DOWN" button, reduce time of delay shutdown;
23. "UP" button, increase time of delay shutdown
24. LED lights display, set the delay time for viewing each interface and enter
25. Auto and manual mode switch;

The TL-Timer is installed inside the lower right hand door panel, see below.

### Operation:

#### Normal use:

The TL-Timer is selected Auto mode as factory setting.

Under Auto mode, when the laser is not at work, air assist and exhaust fan won't be on; When the laser is working, the air assist and exhaust fan starts, after the job finished, the air assist will stop after 20 second, exhaust fan will stop after 30 second.

Under Manual mode, when the laser is powered on, the air assist and exhaust fan will be on all the time  
Each "OUT" interface has a freely adjustable delay time from 0-99 seconds.

#### Set up delay time:

Generally, there's only need to set up the delay time for air assist and exhaust fan, so they can be delay to shutdown according to your need. The default for air assist is 20 second, and for exhaust fan is 30 second.

Click "Set" button to select from OUT1 to OUT8 interface and the LED light display will show you the delay time in second for each interface. On each interface, click "down" or "up" button you can change the value, then click "Set" button to confirm and go into the next interface. On the OUT8 interface, click again the "Set" button, the display will be off and exit the delay time setup.

This will increase the ease of use of your laser machine.



## 4.8 How to use air-assist control (IF EQUIPPED)

The Air-assist control is an additional tool for laser machines.

Generally, cutting needs the air assist with high air-volume but engraving needs the air assist with low air-volume.

Air-assist control is available in high- and low-volume for engraving and cutting-jobs via software-setting, this will increase the ease of use of your laser machine.



### 1) How to select the air assist with high volume or low volume?

In RDworks software, high volume or low volume is selected on the "Air-Assist Control" option. We suggest select "High" for cut mode and select "Low" for scan mode (engraving mode).

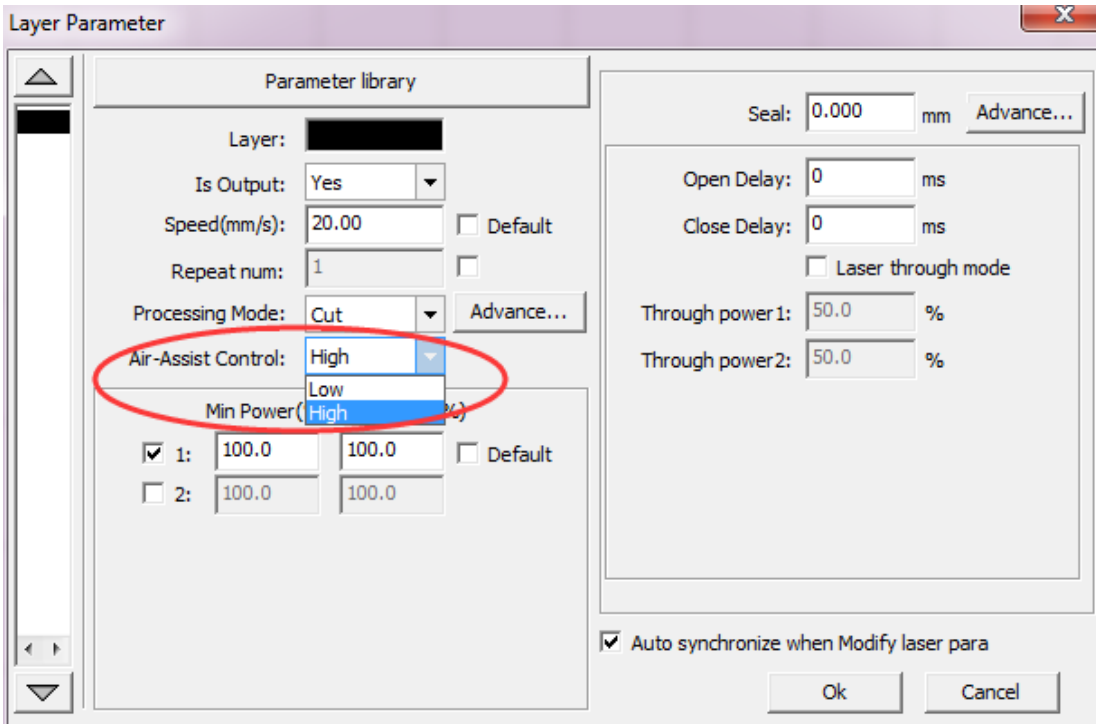

You can also set default for “Air-Assist Control” option, so in cut mode, it will select High volume automatically, and in scan mode (engraving mode), it will select Low volume automatically.

**How to set default for “Air-Assist Control” option?**

Go into the RDworks’s root directory>>open the text file of “soft”>>change the setting of “ShowBlow”>>save the text file, like below.

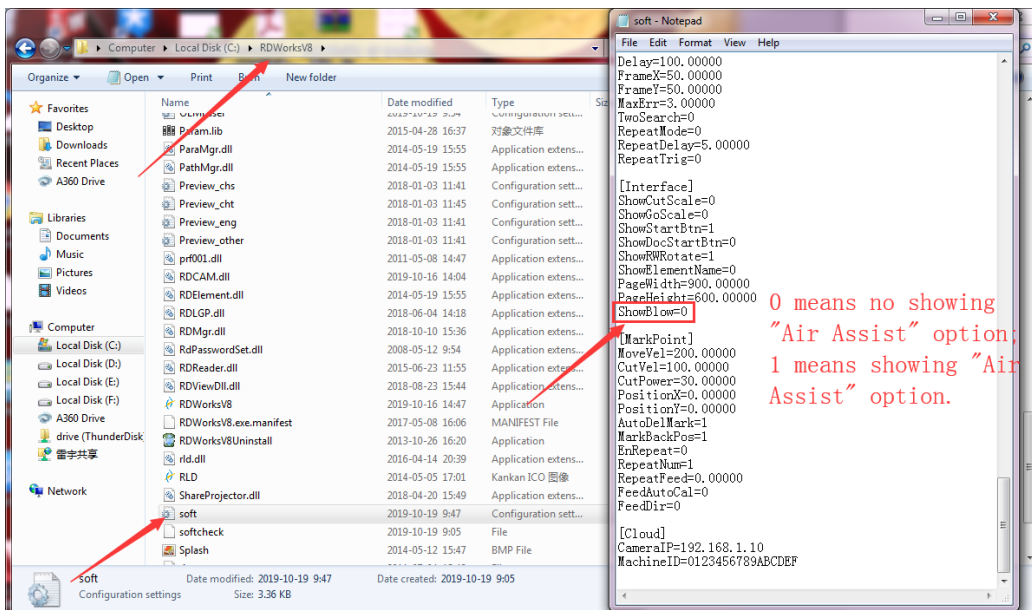

**2) How to adjust air volume if require?**

For High volume mode,

[www.thunderlaser.ca](http://www.thunderlaser.ca)  
[sales@thunderlaser.ca](mailto:sales@thunderlaser.ca)  
Tel: +1403-814-9808

1. Make sure machine is not at work and laser switch is off
  2. Click the left green button to start the air-assist with high volume
  3. Check the air volume under the laser head
  4. On left flow control valve, loose the locked nut then rotate the adjusting screw to control the air volume to mean your requirements.
  5. Fix the locked nut after finished.
- And for Low volume mode, you do it the same.



It will be the best if using big air compressor instead of air pump for air-assist.



Also you can refer to the video instruction below:

<https://youtu.be/GmiphyCBP3w>

## 4.9 How the heat alarm system works

The heat alarm system is an additional tool for laser machines.

Some materials such as acrylic, wood and so on, can easily catch fire, particularly during cutting.

The heat alarm system has a smart board with temperature sensor which will be reacted by an abnormal temperature (higher than 55°C/131°F) on working table. It will trigger at a certain temperature then signals to TL-Timer board to stop laser processing and give a warning sound, so operator can active fire control in time to reduce the potential losses and risks.

The warning sound comes from signal lamp (roughly 80dBA within 1m, 75dBA within 5m and 65dBA within 10m, the sound gets weaker as it travels).

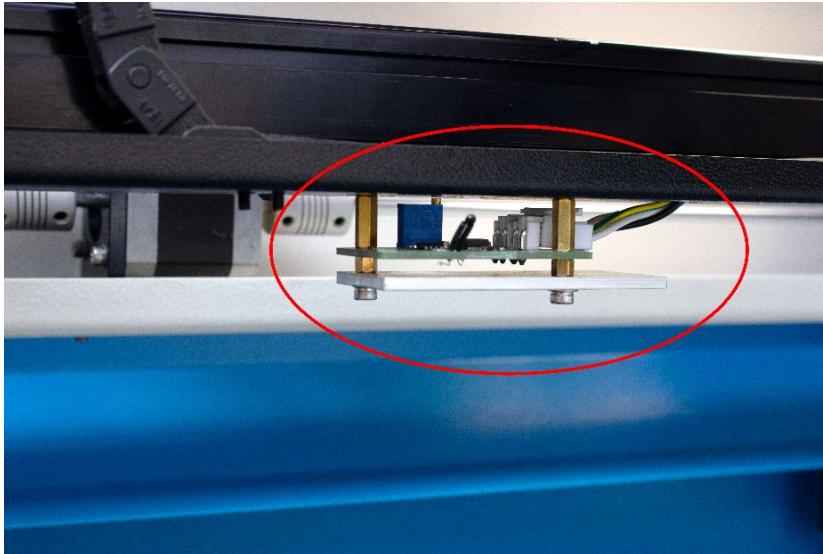

When heat alarm system is activated, the warning sound will beep all the time until user restart the machine.

## 4.10 The First Time Running the Laser



To be safe, never ever run the laser system unattended.



According to international standard,“O”means close;“I”means open for the rocker switch below

### Yours first engraving tests

The following steps describe how to successfully engrave a first pattern. Please follow the individual steps:

1. Switch on you Laser and wait for a beep to note the machine is initialized, and the laser head will do the reset and find the home from top left corner. **DO NOT** click “ESC” button to stop the system initialization.



When turn on the power of machine, and note that turn on the Main switch first and then the Laser switch.

2. After machine finish resetting, adjust the height of working table, place the material usually on the top left corner of the working table.

- ① Move down the working table;
- ② Place the material;
- ③ Move up the working table;

3. With the help of the focus tool, adjust the focus distance to 52.5mm between the focus lens and the material manually by move up and down the working table.

4. Open the software RDworksV8.First to set up the values on the “Scanning(Reverse compensation)” check box.

Open Config(s)>>system setting>>Optimize>>Scanning(Reverse compensation),and there are some default values on the “Scanning(Reverse compensation)” check box.

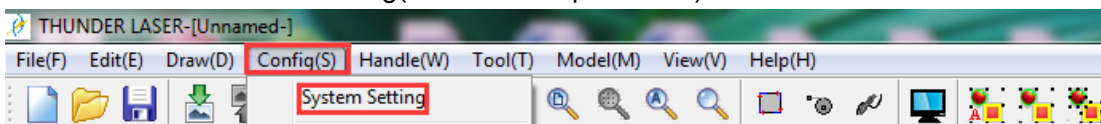

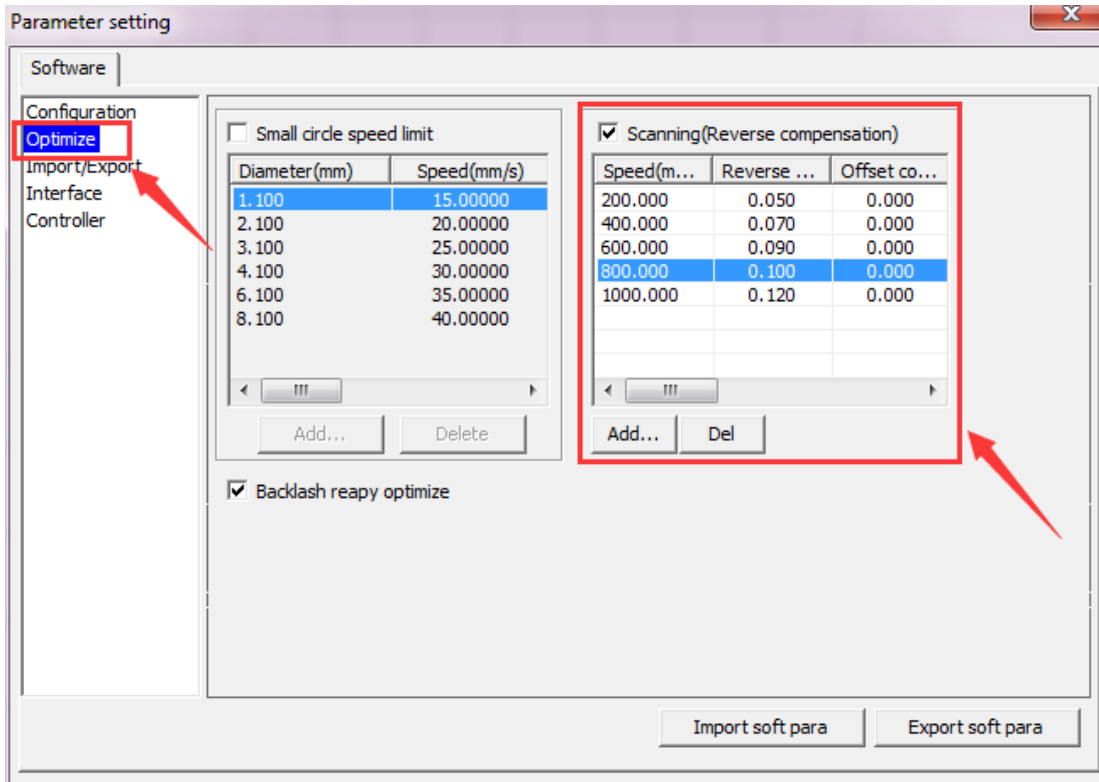

The particular values are showing with a picture in folder of laser software on the USB flash drive and on the Anodized aluminum piece that came with your machine.

Save those setting on the “Scanning(Reverse compensation)” check box.

5. Create sample text for engraving directly on RDWorks, then set up the parameter and download the file to your machine.

More details for how to use software please watch the instruction video below.

<https://www.thunderlaser.com/video/how-to-use-your-laser-software.html>

6. Click “Original” and “Frame” on the display, please make sure that the material is in the right location and there is enough space for working.

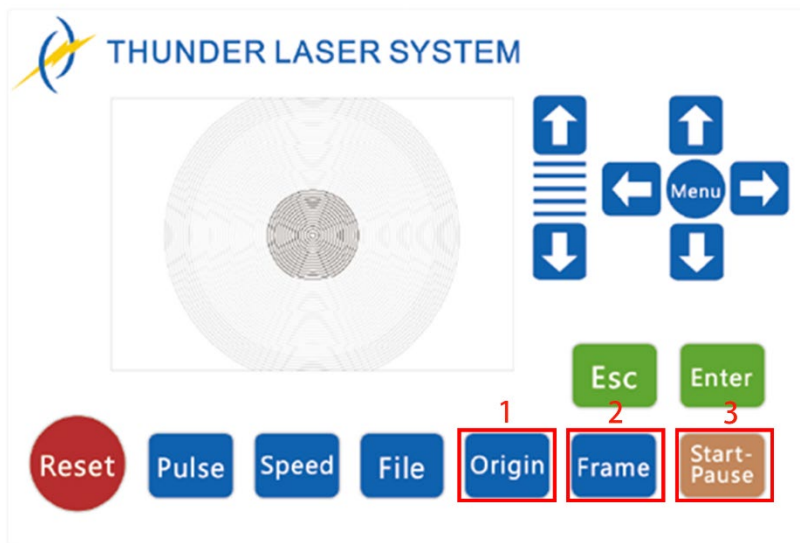

- ① Control arrow button to move the laser head;
- ② Click “Origin” button to select the start point;
- ③ Click “Frame” button to be sure the working area;
- ④ Click “Start-Pause” to run the program;

7. Please check the water cooling system is working properly; the water is running into and filling the laser tube. Please do not start your work if the laser tube isn't full of water, because that may led to laser tube damage due to the high temperature.

8. Finally press the “Start-Pause” button in the display, to start the engraving process.

9. While the laser is engraving, you can generate the next graphic.

10. When the engraving is complete, the laser machine will give out the notification sound and the laser head will go back to the original point, and the warning light will return to the green light, then you can repeat engraving.



This is software specific, so if you are using LightBurn, you will need to do this in LightBurn. It is called “Scanning Offset Adjustment.”



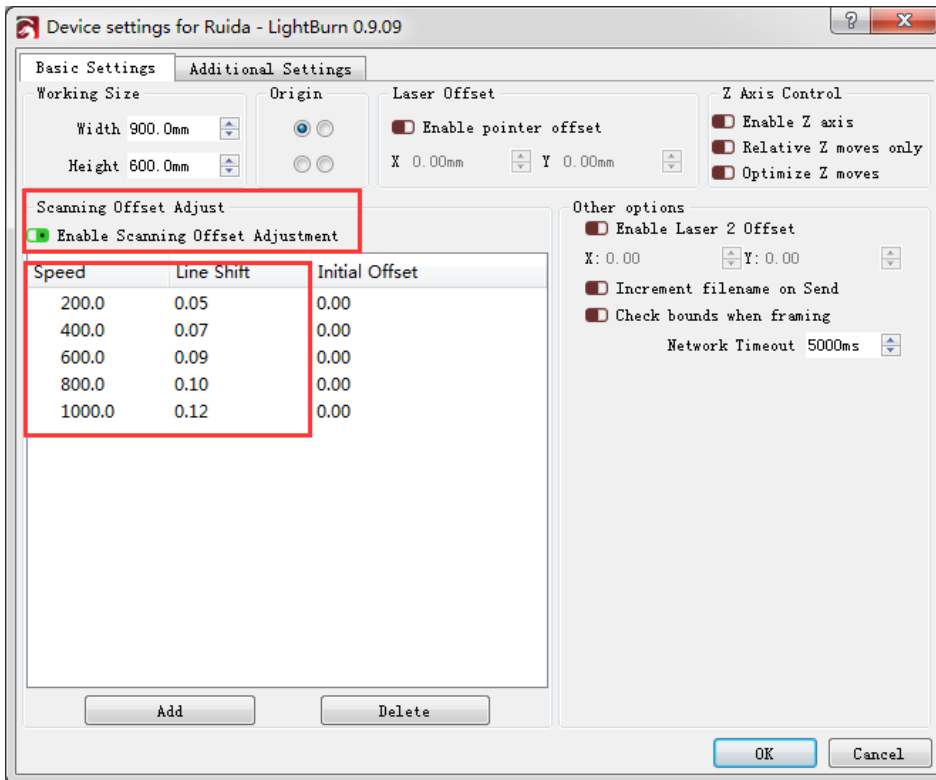



### 4.11 Workstation Area Indication

## Side view

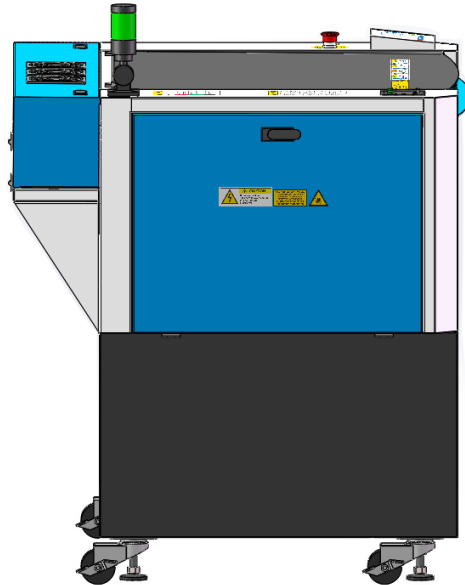

Workstation  
area occupied  
by operators

## Plain View

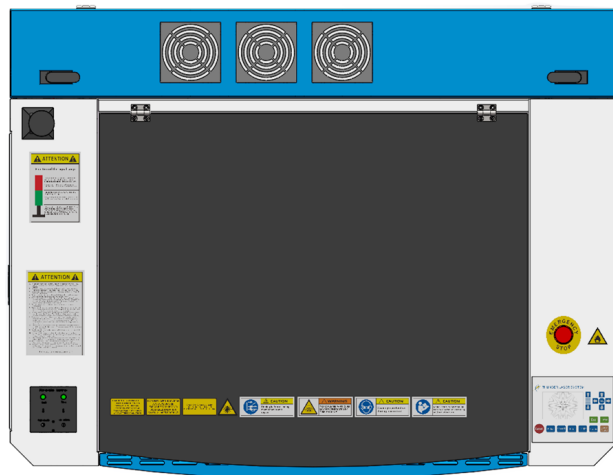

Workstation area occupied by operators

## 4.12 How to use the Chuck Rotary axis Attachment

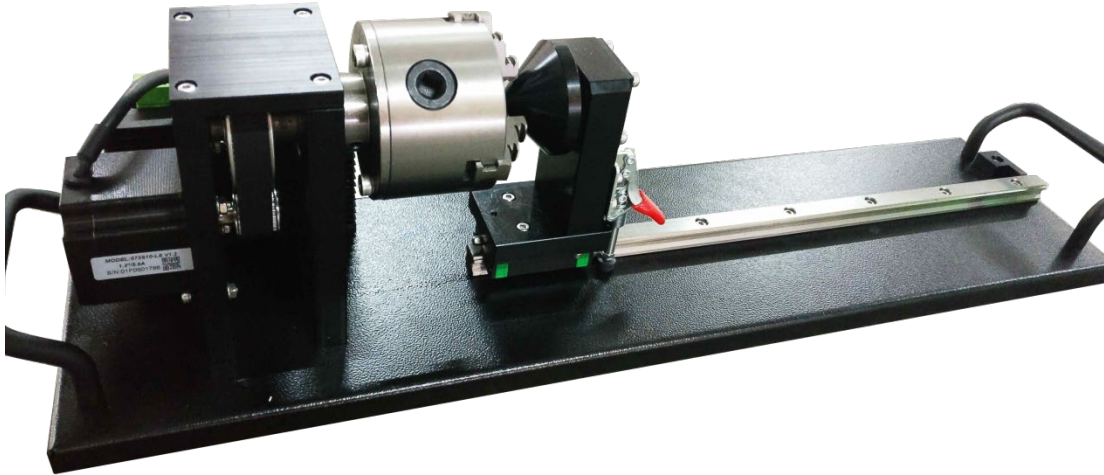

The chuck rotary axis attachment is the optional item.

Specification:

W×D×H	23.62"×6.69"×5.91"/600mm×150mm×170mm
Max working length	11.42"/290mm
Max working diameter	3.94"/100mm

To install and set-up the rotary axis attachment proceed as described as follows:

1. Move the working table to the lower position then switch off the laser and open the top lid.
2. Put the rotary axis attachment onto the working table and align the rotary attachment with the x-axis are parallel, with the jaw chuck closest to where the rotary attachment plugs in.
3. Connect the rotary axis attachment via the control cable with the connector of the motion system. The connector is located inside the right front of the laser. Connected it to this interface and fixed, and then you have finished the device connection. Like below:

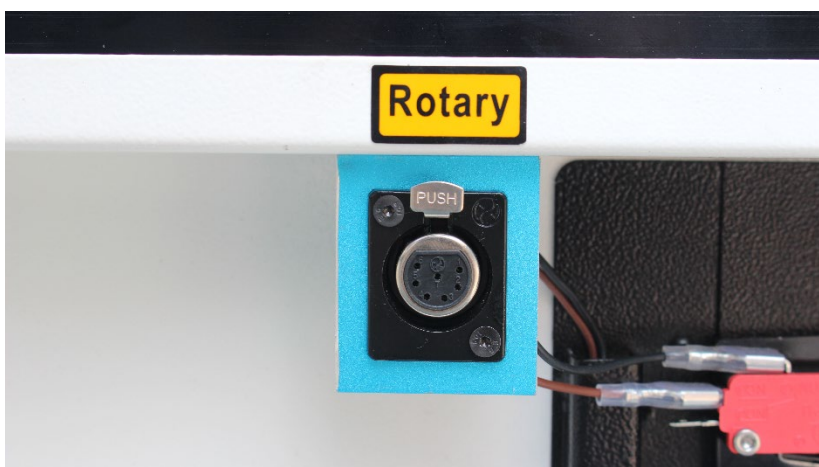

4. Before you mount the object into the rotary axis attachment, measure the diameter of the object at the

position to be engraved with a sliding caliper or a similar tool. Write down this value. For example: 80mm.

5. Adjust and fix the slider to make the work piece fitting into the rotary axis attachment.
6. Set your focus manually, carefully and safely. It is not recommended to use the auto focus with a rotary axis attachment for the simple reason that you are not working with a flat object. Set your origin
7. Generate a graphic with the help of the graphics software. The graphics size must be adjusted until less than the dimensions of the work piece.
8. Select "Output", and then input the diameter of the object and the circle pulse. How to set up the parameter for "enable rotate engrave", please click below link for the instruction  
<https://www.thunderlaser.com/uncategorized/rotary-axis-attachment-has-a-wrong-cylindrical-engraving-cutting-size.html>
9. Select "Download", click "Origin" and "Frame" on the LCD display, please make sure that the material is in the right location and enough space for working.
10. Finally press the "Start-Pause" button in the LCD display, to start the engraving or cutting process.

Also you can refer to the video of how the rotary axis works in our website:

<https://www.thunderlaser.com/how-to-use-your-laser-machine/how-the-rotary-axis-works.html>

## 4.13 For Laser Engraving

The engraving depth can easily be varied through the laser power or the speed. To increase the engraving depth, reduce the speed or increase the power setting. This way you increase the amount of energy per area unit. Engraving too deep, however, reduces the quality of the details. With coated materials the required power depends of the kind and thickness of the coating. With power set too high the individual lines become too thick and a sharp picture cannot be achieved. The resolution of the graphics should usually be at 500 dpi. The dpi setting (number of laser dots per inch) depends on the material. The lower this setting is, the lower the resolution of the engraved picture will be. This, however, reduces flaming and increases the energy of a pulse, which can improve the overall result (e.g. when engraving some sorts of plastic materials).

### 1. Plastics

Plastics for engraving are available in many different colors and thicknesses and with many different coatings and surfaces. The majority of available plastics can be well engraved and cut with the laser. Plastics with a micro-porous surface seem to give the best result, because less surface material needs to be removed. As most plastic materials have a low melting point, a low pip setting should be selected to reduce the danger of melting.

### 2. Acrylic

There are two different types of acrylic – cast and extruded. The cast acrylic becomes white or mat after engraving, the extruded acrylic remains clear. Use extruded acrylic for engravings that are filled with paint and cast acrylic for normal engravings. Cast acrylic can be best engraved without protection foil. It is better to engrave the entire surface with a low energy setting.

### 3. Engrave the rubber stamp

The various mixtures and densities of rubber plates cause a slightly varying engraving depth. The settings in the overview table give a good indication. Since engraving a standard rubber material requires a relatively high laser power, the laser power is principally set to 40% or more high and only the speed is varied. Due to their lower density, so-called micro porous rubber materials allow a significantly higher engraving speed. Test the rubber first, to find out the correct speed setting.

The RDWorksV8 software using the engraving function, you can choose “Ramp Effect” or common engraving, once you choose “Ramp Effect” and you will need to set a minimum power lower than Max Power, generally we set it to about 15%, and input a value with the Ramp Length what you want, but if you want to make it better, you may need to test different kinds of power and speed by yourself, then you can get the best result.

Engraving rubber produces a considerable amount of dust and terrible gas. Therefore a well-dimensioned exhaust system and its regular maintenance are very important.

## Chapter 5. Maintenance

### 5.1 Cleaning the Laser Machine



Caution – use of controls or adjustments or performance of procedures other than those specified here in may result in hazardous laser radiation exposure.

Before starting cleaning and maintenance work always switch off the device and unplug the mains plug.

Always keep the system clean, as flammable parts in the working area or exhaust area rise the fire hazard.



You should check at least once a day, whether dust has accumulated in the engraving system.

In case of soiling the machine must be cleaned. The cleaning interval strongly depends on the material that is being processed and the operating time of the device. Please bear in mind that only a clean machine guarantees optimal performance and reduces the service costs.

#### General Cleaning Notes:

1. Make sure, that the device is switched off and unplugged. Open the protective cover.
2. Move the working table into a position in which it is easiest for you to clean the surface with a window cleaning agent and paper towels.
3. Thoroughly remove all loose dirt particles and deposits in the interior of the machine.
4. Clean the cover of the laser tube.
5. You can clean the viewing window with a cotton cloth. Do not use paper towels as they could scratch the acrylic.

## 5.2 Cleaning the Optical Parts

The lens has a durable multi-coating and won't be damaged by correct and careful cleaning. You should inspect the focus lens and the mirrors and the beam combiner according the maintenance plan. If you discover a veil of haze or dirt, you must clean them.



It is suggested to clean the mirrors/lens before work every day in order to run the machine at max efficiency. **Please turn off the power of laser machine before cleaning the optical parts.**



1. Lens cleaning fluid and cotton swabs are in the tool box that came with the machine.
2. The lens must be cleaned carefully with a clean cotton swab to avoid scratching the surface of the lens.
3. Do not touch the lens with your hands after wiping.
4. Never use a cleaning swab twice.

Follow the instructions below for the cleaning of optical parts:



### 5.2.1 Cleaning the Focus Lens

1. Move the working table to a distance approx. 10 cm under the lens holder.
2. Move the working head into the center of the working surface.
3. Now you can loose the two black screws slightly, then take the lens out.
4. Remove the coarse dust as good as possible by blowing air onto the lens surface.
5. Check the surface and if necessary clean the lens with the lens cleaning liquid and swabs.
6. Put some lens cleaning liquid on one side of the lens. Leave the liquid to take effect for approximately one minute and then gently wipe it away with cleaning swabs soaked with lens cleaning liquid.
7. Finally, dry this side of the lens with dry cleaning swabs and repeat the cleaning process on the other side of the lens. Never use a cleaning swabs twice. Dust accumulated in the cleaning swabs could scratch the lens surface.
8. Examine the lens. If it is still soiled, repeat the cleaning process until the lens is clean.
9. Carefully tight the lens holder.

**How to take out the focus lens, please just as following the picture indicated:**

1. Turn the two screws counterclockwise

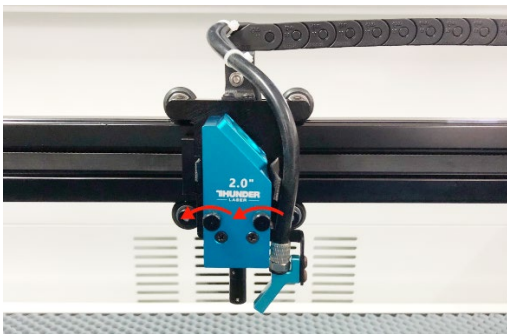

2. Pull the focus lens out

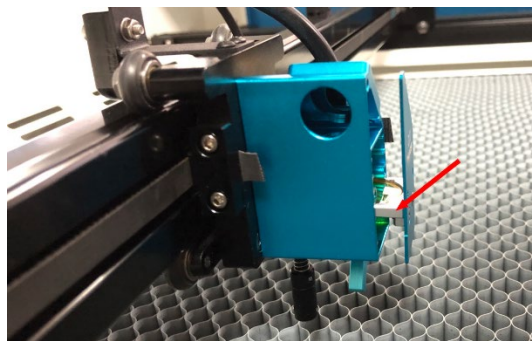

3. Clean concave side of lens with swabs

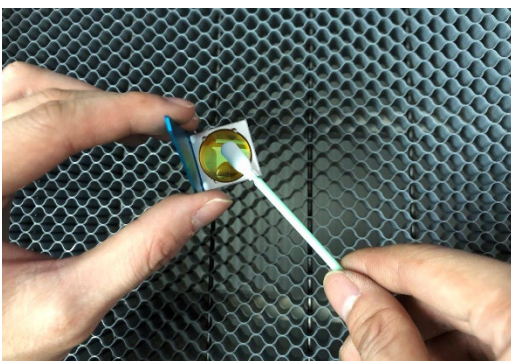

4. Clean convex side of lens with swabs

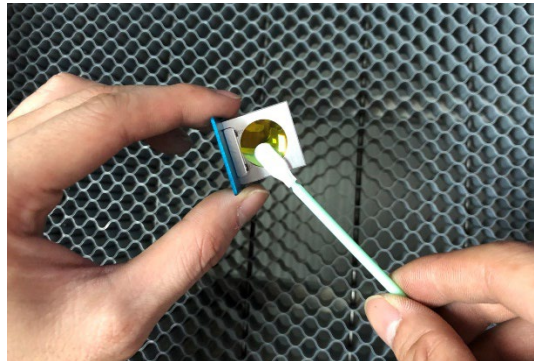

### 5.2.2 Cleaning the Mirrors

There are three mirrors in the operating area of the laser, which may have to be cleaned if they are soiled. To clean the reflector, follow the instructions below.

1. Remove the coarse dust as good as possible by blowing air onto the mirror surface.
2. Check the surface and if necessary clean the mirror with the mirror cleaning liquid and swabs.
3. Put some lens cleaning liquid on one side of the mirror. Leave the liquid to take effect for approximately one minute and then gently wipe it away with cleaning swabs soaked with lens cleaning liquid.
4. Finally, dry this side of the mirror with dry cleaning swabs and repeat the cleaning process on the other side of the mirror. Never use a cleaning swabs twice. Dust accumulated in the cleaning swabs could scratch the mirror surface.
5. Examine the mirror. If it is still soiled, repeat the cleaning process until the lens is clean.

#### The Mirror#1

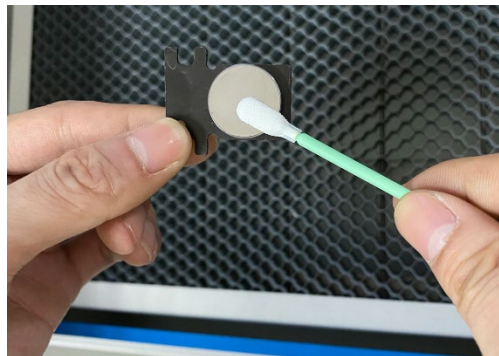
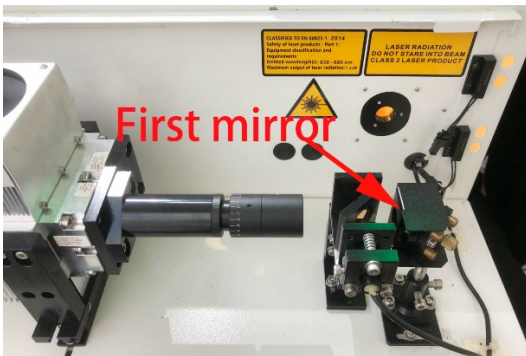

The 1<sup>st</sup> mirror is installed in the rear box of the laser tube, open it then view the right side.

#### The Mirror#2

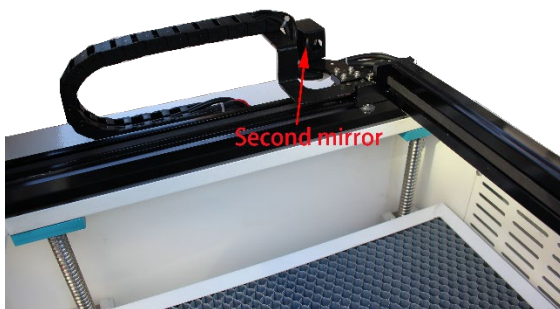

The 2<sup>nd</sup> mirror is installed on the left side of X rail.



**The Mirror#3**

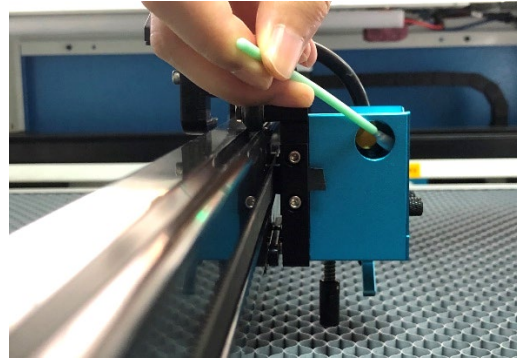
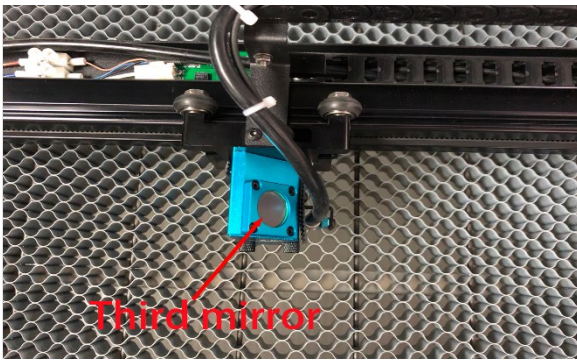

The 3<sup>rd</sup> mirror is installed on the top of the laser head.

**How to take out the mirrors, please just as following below indicated:**

**Mirror 1&2**

1. Unscrew the screw of the mirror

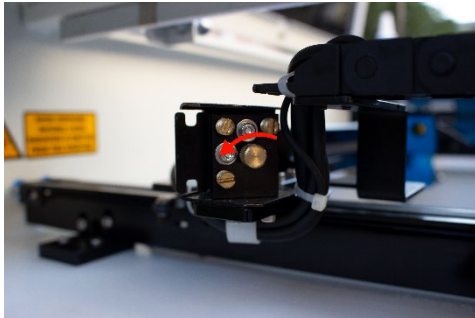

2. Pull the mirror out

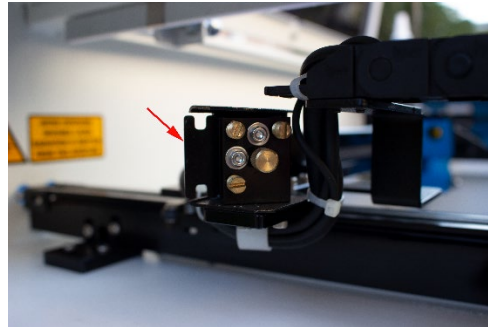

**Mirror 3**

Unscrew the four screws

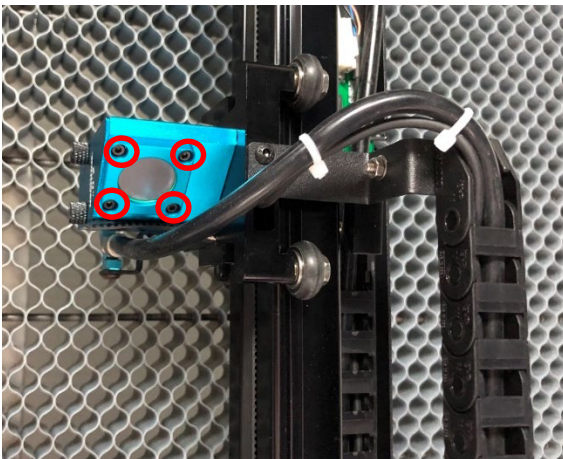

Except for replacement, there is no need to remove the 3rd mirror.

### 5.2.3 Cleaning Laser Combiner

1. The laser combiner is installed on the left side of the first mirror.
2. Remove the coarse dust as good as possible by blowing air onto the combiner surface.
3. Check the surface and if necessary clean the laser combiner with the lens cleaning liquid and swabs.
4. Put some lens cleaning liquid on one side of the swab. Leave the liquid to take effect for approximately one minute and then gently wipe it away with cleaning swabs soaked with lens cleaning liquid.
5. Finally, dry this side of the laser combiner with dry cleaning swabs and repeat the cleaning process on the other side of the lens. Never use a cleaning swab twice. Dust accumulated in the cleaning swabs could scratch the combiner surface.
6. Examine the laser combiner. If it is still soiled, repeat the cleaning process until it is clean.

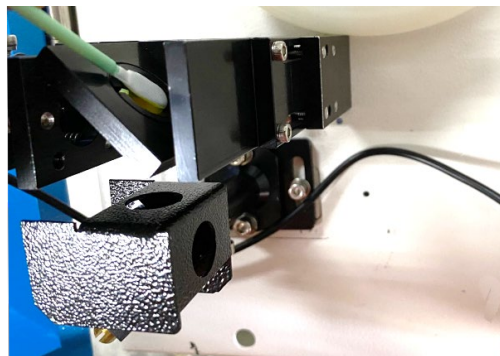

### 5.3 Check the Beam Path

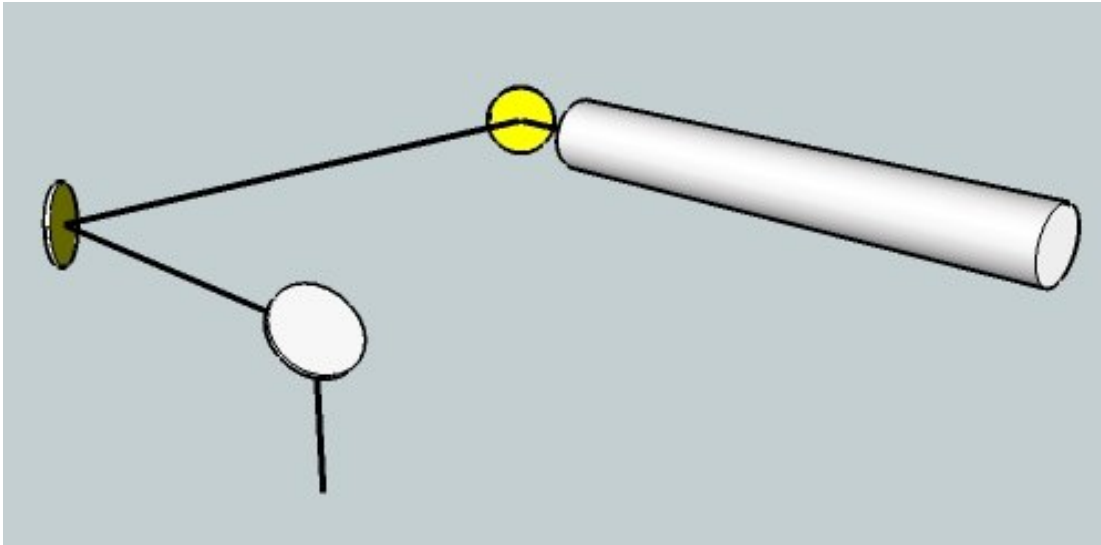

After being used for a long time, the beam path might be deflective. This will reduce the efficiency of the laser beam or even cause no laser beam. At this moment, you will need to re-adjust the beam path again.

If you need to know that about adjust the laser beam path of the video on YouTube released by our company and please link to the URL:

<http://www.thunderlaser.com/how-to-use-your-laser-machine/how-to-adjust-the-laser-beam-path.html>

## 5.4 Maintain the X/Y/Z Rails

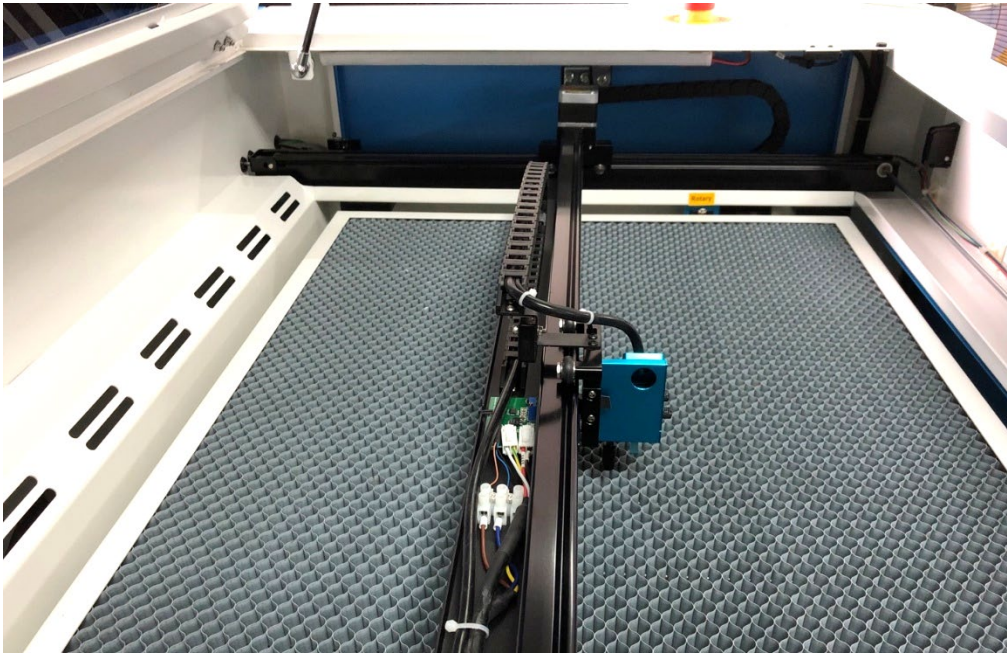

It is suggested to clean the dust on the X/Y rail with alcohol at least every two weeks.



It is suggested to add lubricant oil (or Rust Preventative Grease) to the bars/screws at least every two weeks.



## 5.5 Maintenance Plan

### 1. DAILY CHECK LIST

- ① Check Mirrors and lens for condensation and make sure it is clean after work
- ② Check exhaust grille to ensure there is no blockage for exhaust fan
- ③ Check air filter on compressor
- ④ Ensure cooling fans on sides are free from debris
- ⑤ The air blower must be checking and cleaning if required

### 2. WEEKLY CHECK LIST

- ① Clean debris from under laser bed
- ② Clean rails and lubricate the bar as required
- ③ Clean Acrylic/Tempered glass covers in lid
- ④ The beam combiner must be checking every weekly, and cleaning if required
- ⑤ Clean the exhaust fan to ensure there is no blockage

**THE END**